

SHOP MANUAL

HONDA

Z50A

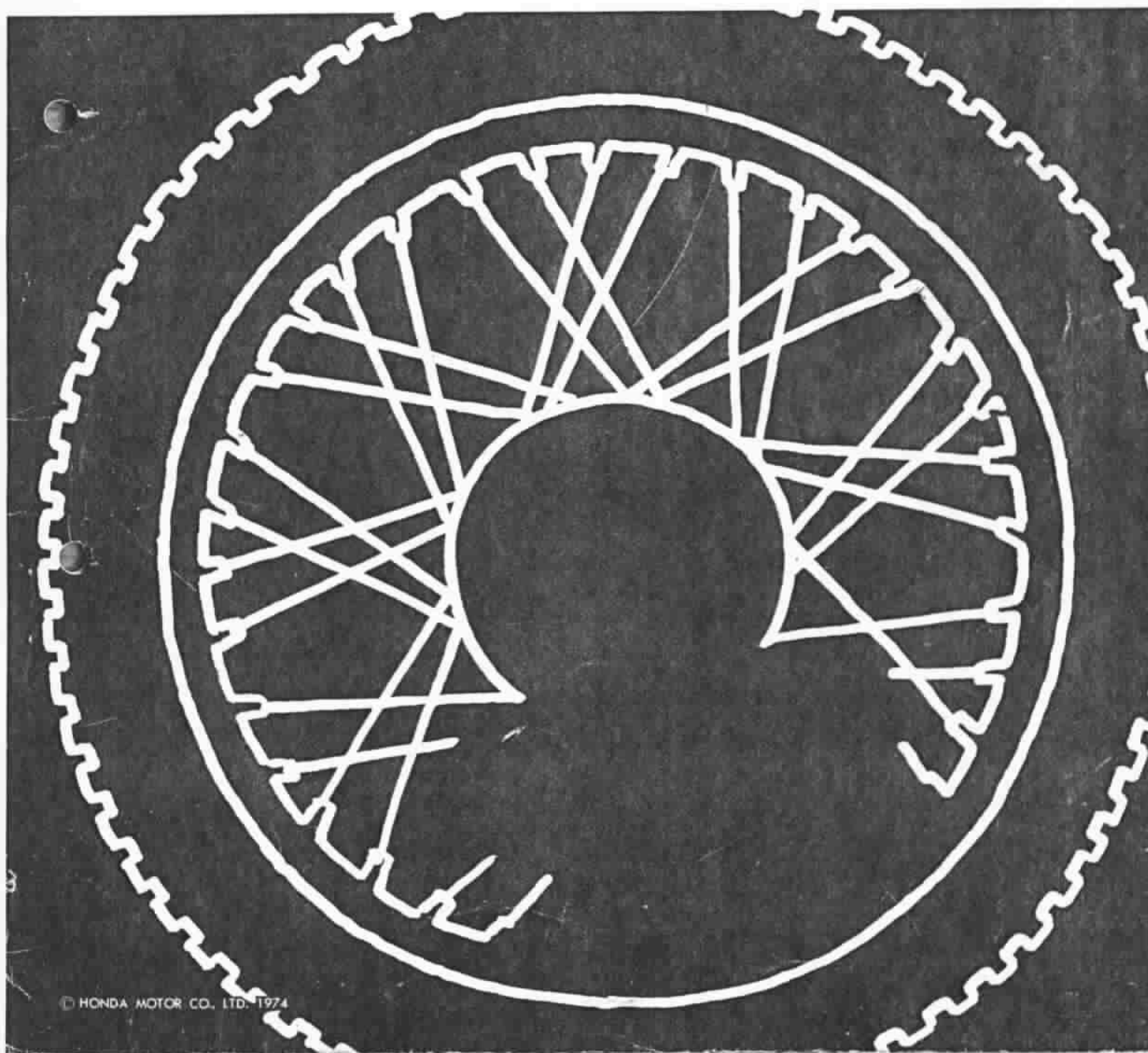

FOREWORD

This Manual Z50AK5 covers all information on the models Z50A, Z50K2, Z50AK3, Z50AK4 and Z50AK5. At the end of the manual are listed main modifications and servicing of the models mentioned above basing upon the model Z50AK2 for quick reference.

Following are the initial numbers of each model at the time of change

Model	Serial number
Z50A (basic model) U.S.A. type only :	Z50A-100001~Z50A-120087
Z50A U.S.A. type :	Z50A-120088~Z50A-270235
Z50AK2 U.S.A. type :	Z50A-270236~
Z50AK3 U.S.A. type :	Z50A-1000001~
Z50AK4 U.S.A. type :	Z50A-3000001~
Z50AK5 U.S.A. type :	Z50A-5000001~
Z50A General export type :	Z50A-156932~Z50A-298503
Z50AK2 General export type :	Z50A-298504~

HONDA MOTOR CO., LTD.

Service Publications Office

CONTENTS

MAIN FEATURES OF Z50A	1
SPECIFICATION TABLE	3
SPECIAL TOOL SET	4
ENGINE	6
1. Engine Assembly Diagram	6
2. Engine Removal	7
3. Engine Installation	7
4. Lubrication (Oil Pump)	8
5. Cylinder and Cylinder Head	9
6. Piston and Piston Ring	15
7. Clutch	17
8. Crankshaft	18
9. Transmission	20
10. Gear Shift Mechanism	21
11. Kick Starter	23
12. Carburetor	24
TROUBLE SHOOTING TABLE	27
FRAME	
1. Front Suspension	31
2. Rear Brake	31
FRAME (K3, K4, K5)	
1. Front Suspension	34
2. Function of Rear Suspension	34
3. Cam Chain Adjustment	35
4. Drive Chain Maintenance	35
5. Front Wheel and Front Brake	39
6. Rear Wheel and Rear Brake	42
7. Steering System	45
8. Front Shock Absorbers	47
9. Rear Suspension	48
10. Frame Body, Seat, Tank and Air Cleaner	50
11. Electrical System	52
TECHNICAL SERVICE DATA	54
TORQUE SPECIFICATIONS	56
WIRING DIAGRAM	57

MAIN FEATURES OF Z50A

- The overhead cam design enables a quiet operation and a constant high output over a broad speed range starting at slow speed with very little effort.
- Incorporation of the oil damper type cam chain tensioner automatically maintains the proper tension and minimizes the chain noise, further, chain adjustment is unnecessary.
- Riding is simplified by the use of the automatic clutch which is interconnected with the gear change pedal.
- Metal screen and centrifugal filter assures only clean oil to lubricate the critical moving parts.
- Foldable handle bar makes storing in narrow space possible.
- Frame is welded pipe backbone design having a double channel welded to a single main pipe to reduce weight.
- To prevent spillage of fuel during transportation fuel shut off valves are provided in the filler cap and the carburetor.

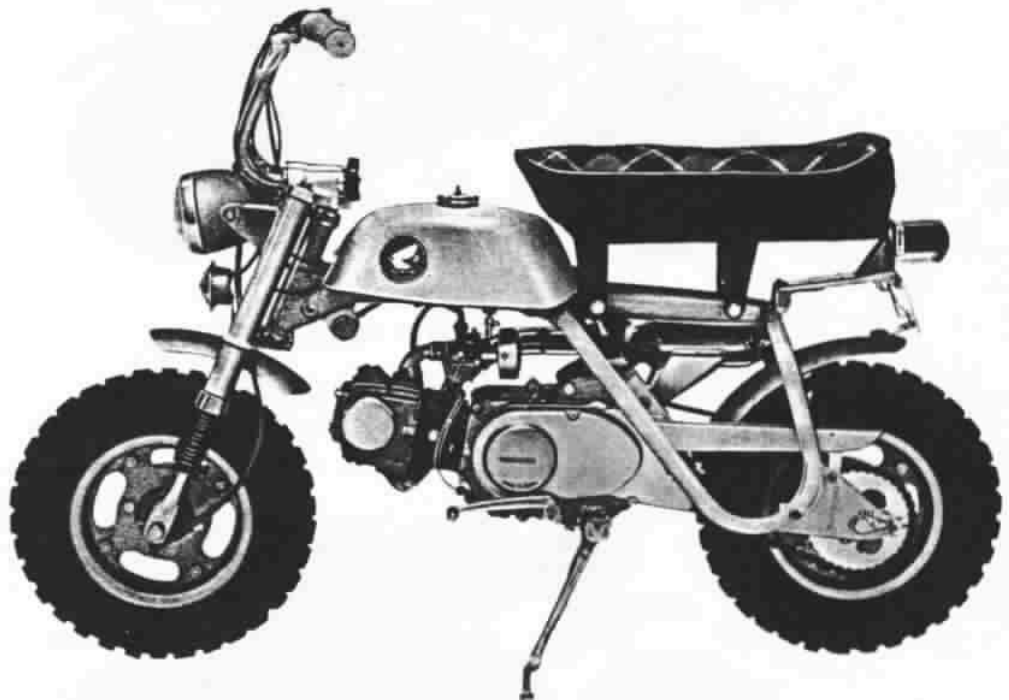

GENERAL EXPORT TYPE

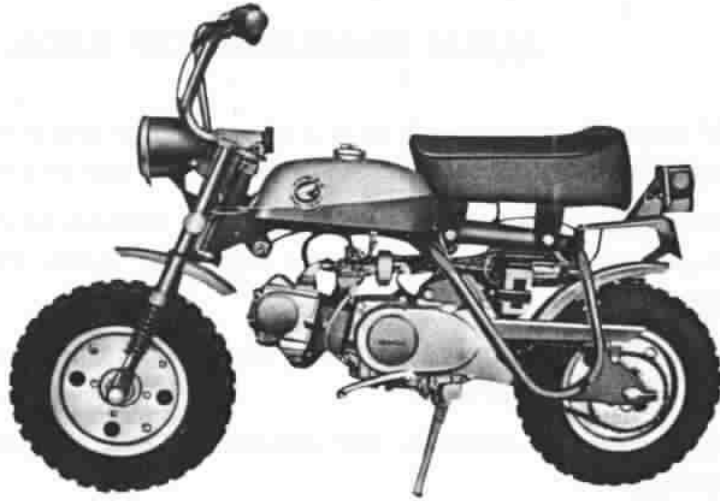

TYPE (From F. No. 120001)



U.S.A. TYPE (From F. No. 270236)



TYPE (From F. No. 5000001~)

SPECIFICATION TABLE

	GENERAL EXPORT TYPE	U.S.A. TYPE (From No. F 120001)	U.S.A. TYPE Z50A-K2 (From No. F. 270236)	U.S.A. TYPE Z50A-K3, K4, K5 (From No. F 1000001) (From No. F 3000001) (From No. F 5000001)
DIMENSION				
Overall length	1,270 mm (50.0 in)		1,280 mm (50.4 in)	1,300 mm
Overall width	635 mm (25.0 in)	590 mm (23.2 in)	580 mm (22.8 in)	610 mm
Overall height	1,000 mm (39.4 in)	860 mm (33.9 in)	865 mm (34.1 in)	850 mm
Wheel base	880 mm (34.7 in)			895 mm
Min. ground clearance	170 mm (6.7 in)			150 mm
Curb weight	49 kg (108 lbs)	50 kg (110 lbs)	53.5 kg (118 lbs)	56 kg (123 lbs)
FRAME				
Suspension (F)	Telescopic fork			Telescopic fork
Suspension (R)	Rigid frame			Swing arm
Brakes	Internal expansion			Internal expanding, 124 cm ²
Fuel tank capacity	2.5 lit. (0.7 U.S. gal., 0.6 imp. gal.)			3.8 lit. (1.0 U.S. gal., 0.8 imp. gal.)
Trail	40 mm (1.57 in)			42 mm (1.7 in)
Caster	67°			65°
Tire size and air pressure (F & R)	3.50-8, 1.0 kg/cm ² (14.2 psi)			F/R: 3.50-8-2 PR, 1.0 kg/cm ² (14.2 psi)
ENGINE				
Cylinder layout	Single, tilt up 10° from horizontal			Single, 80° inclined from vertical
Valve arrangement	OHV, overhead camshaft			Chain driven over head camshaft
Bore and stroke	39 × 41.4 mm (1.535 × 1.630 in)			39.0 × 41.4 mm (1.535 × 1.630 in)
Compression ratio	8.8:1			8.8:1
Displacement	49 cc (3.0 cu-in)			49 cc (3.0 cu-in)
Oil capacity	0.8 lit. (1.7 U.S. pt., 1.4 imp. pt.)			0.8 lit. (1.7 U.S. pt., 1.4 imp. pt.)
Lubrication	Pressure lubrication & wet sump			Forced and wet sump
Oil filters	Centrifugal and screen mesh			Centrifugal and screen mesh
Reduction ratios				
Primary	3.722			3.722
Secondary	2.615		2.917	—
Gear ratios				
1st	3.182			3.182
2nd	1.824			1.824
3rd	1.190			1.190
Starting method	Kick starter			Kick starter
PERFORMANCE				
Max. torque	0.31 kg-m/4,200 rpm (2.2 ft-lb/4,200 rpm)			0.28 kg-m/4,000 rpm (2.02 ft-lb/4,000 rpm)
Max. output	1.95 ps/5,000 rpm			—
Min. turning circle	2.6 m (8.6 ft)			2.6 m (8.6 ft)
ELECTRICAL				
Ignition	Flywheel magneto			Flywheel magneto
Spark plug	NGK C-6 H or ND U20FS			NGK C6H or ND U20FS
Head light	6V-15W		6V-15/15W	6V-15/15W
Tail/stop light	6V-8/3W		6V-17/5.3W	6V-5.3 watt

SPECIAL TOOL SET

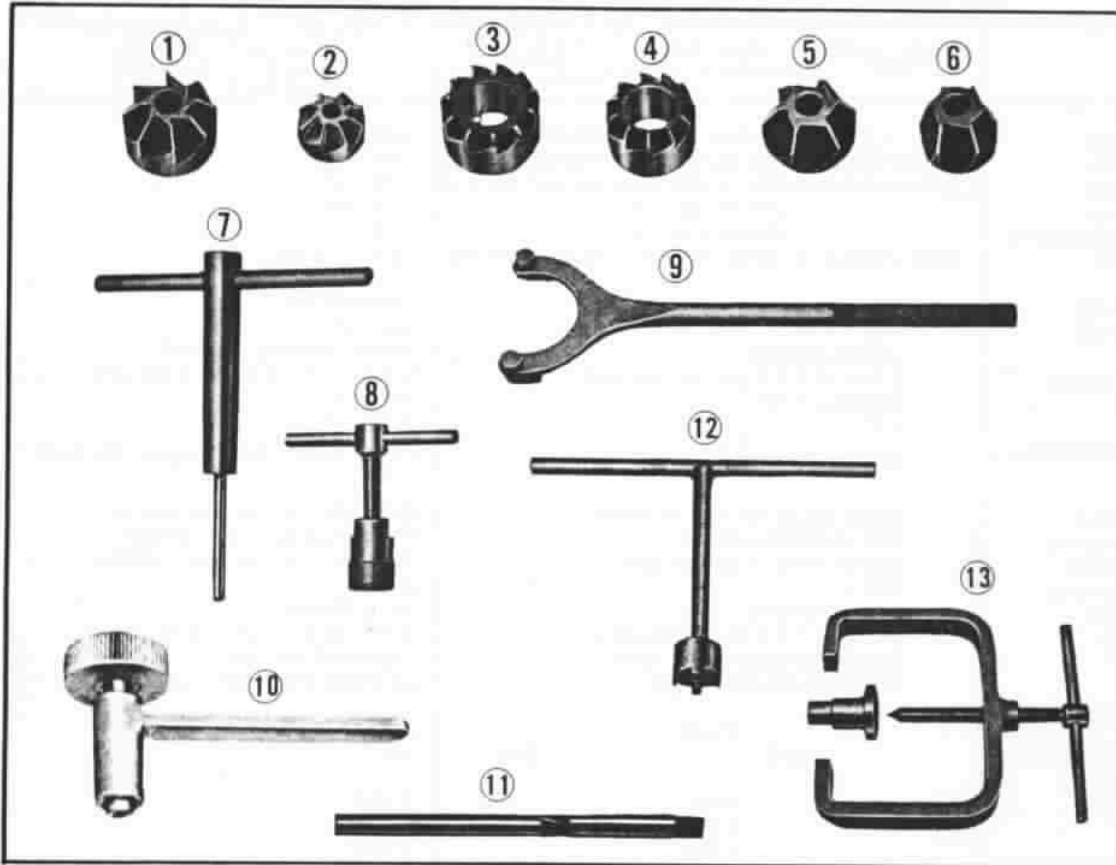

Ref. No.	Tool No.	Description
	07900-0450000	Z50M/Z50A Special tool set
1	07980-0360100	Inlet valve seat cutter, 90°
2	07980-0360200	Exhaust valve seat cutter, 90°
3	07980-0360300	Inlet valve seat top cutter
4	07980-0360400	Exhaust valve seat top cutter
5	07980-0360500	Inlet valve seat interior cutter
6	07980-0360600	Exhaust valve seat interior cutter
7	07981-0360000	Valve seat cutter holder
8	07933-0010000	Flywheel puller
9	07925-0010000	Flywheel holder
10	07908-0010000	Tappet adjusting socket wrench
11	07984-0980000	Valve guide reamer
12	07916-0010000	Lock nut wrench, 14 mm
13	07960-0110000	Clutch disassembly & assembling tool

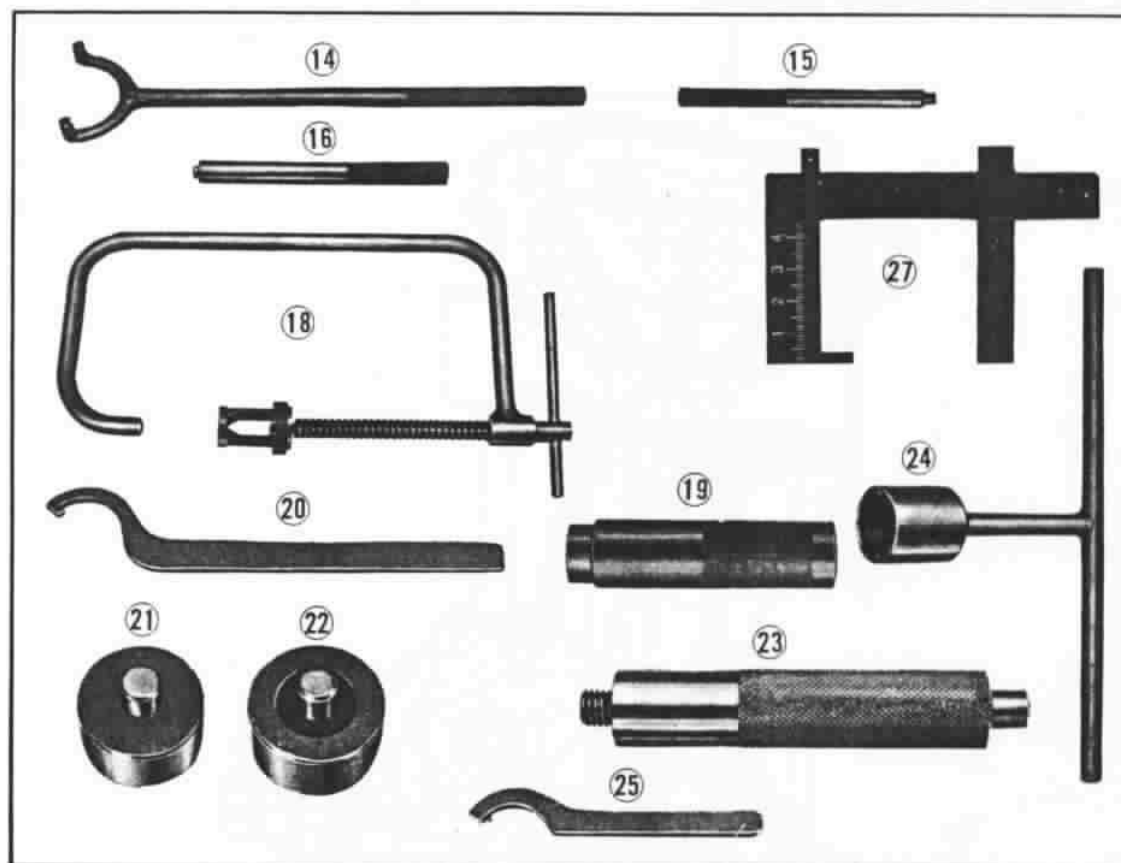

Ref. No.	Tool No.	Description
14	07922-0400000	Drive sprocket holder
	07923-0350000	Clutch outer holder
15	07942-3290100	Valve guide remover
16	07942-3290200	Valve guide driver
18	07957-3290000	Compression valve lifter
19	07945-8150000	Bearing driver
20	07902-0010000	Pin spanner, 36 mm
21	07945-0450000	Front wheel oil seal driver
22	07947-0450000	Rear wheel bearing driver
23	07949-2860000	Bearing & oil seal driver handle
24	07915-0300000	Stem nut socket wrench
25	07902-2500000	Main switch pin spanner
—	07797-0510100	Valve seat cutter case
27	07797-2920300	Float level gauge
—	07401-0010000	Tool case

ENGINE

1. ENGINE ASSEMBLY DIAGRAM

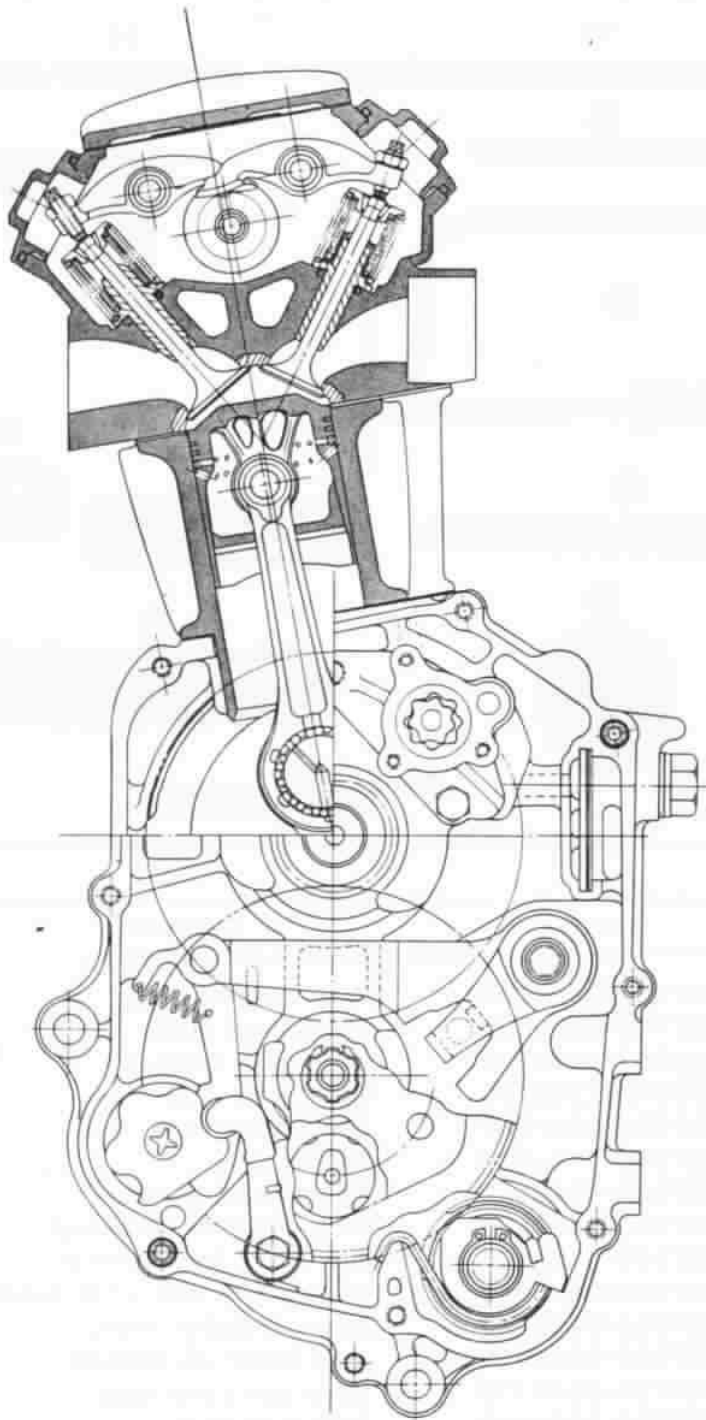

Fig. 1

2. ENGINE REMOVAL

1. Loosen the muffler flange and mounting bolts, and remove the muffler.
2. Disconnect the throttle cable from the carburetor.
3. Detach the high tension cord by pulling the plug cap off the spark plug.
4. Disconnect the electrical wiring (Fig. 2).



① Electric leads coupler
Fig. 2

5. Set the fuel cock to the OFF position and disconnect the fuel tube from the carburetor.
6. Unscrew the left crankcase cover mounting screws and remove the cover.
7. Unfasten the drive chain joint clip and disconnect the chain.
8. Remove the two engine hanger bolts and dismount the engine from the frame (Fig. 3)

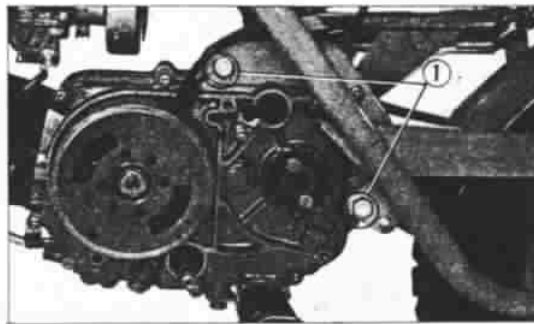

① Engine hanger bolts
Fig. 3

3. ENGINE INSTALLATION

Perform the engine installation in the reverse order of the engine removal described above.

Note: When installing the drive chain joint clip, make sure that the open end of the clip is in the opposite direction to the normal chain rotation (Fig. 4.)

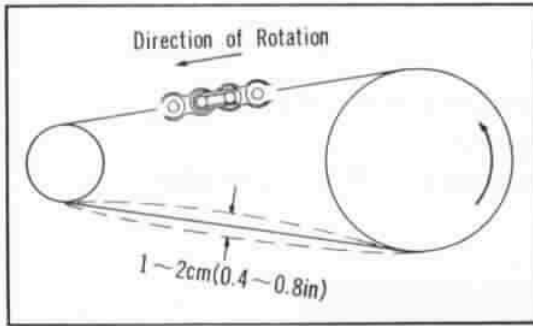

Fig. 4 Chain joint clip installation

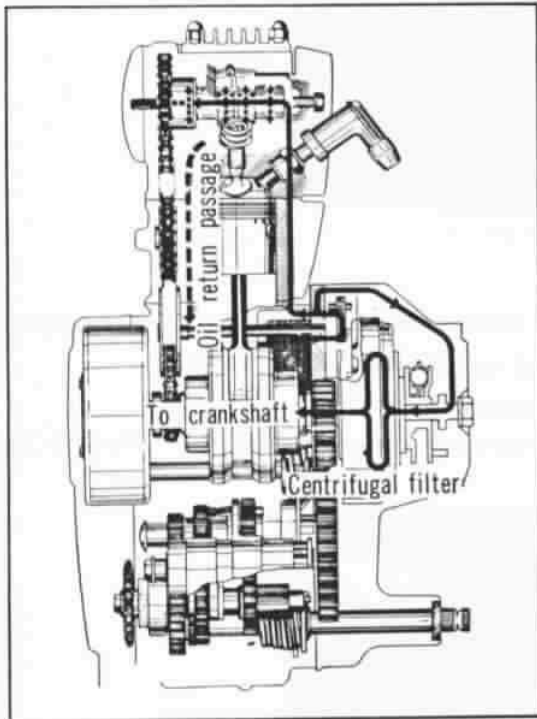
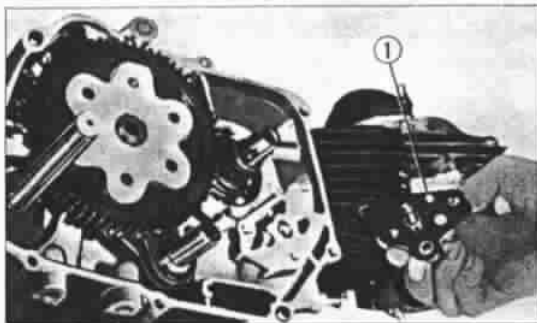

Fig. 5 Engine oil routes



① Oil pump assembly
Fig. 6

4. LUBRICATION (OIL PUMP)

A. Description

The engine oil which has been picked up by the trochoid pump is diverted into two routes (Fig. 5).

Route one:

Oil is sent through the right crankcase
→ right crankcase cover → centrifugal
filter → connecting rod large end rollers.

Route two:

Oil is sent through the cylinder stud bolt
→ rocker arm side cover → camshaft
profiles and bearings → valve mechanism.

B. Disassembly

1. Unscrew the right crankcase cover mounting screws and remove the cover.
2. Remove the clutch outer cover.
3. Unscrew and remove the 14 mm clutch lock nut and washer, and then remove the clutch assembly.
4. Loosen the three 6 mm oil pump mounting bolts and remove the oil pump assembly.
5. Loosen the three cross screws attaching the oil pump cover, the oil pump can then be disassembled (Fig. 6).

C. Inspection

1. Turn the oil pump drive shaft by hand and make sure that it is turning smoothly.
2. Measuring the clearance between the outer rotor and the pump body. Insert the thickness gauge between the outer rotor and the pump body (Fig. 7).

Standard Value	Serviceable Limit
0.004~0.006 (0.10~0.15 mm)	Replace if over 0.0079 (0.20 mm)

3. Measuring the end clearance of the rotor. Place a straight edge across the pump housing and check the clearance of the rotor with a thickness gauge (Fig. 8).

Standard Value	Serviceable Limit
0.0008~0.0027 (0.02~0.07 mm)	Replace if over 0.0047 (0.12 mm)

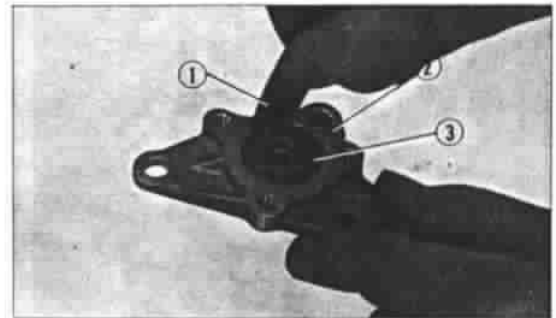

① Thickness gauge ② Pump body ③ Outer rotor
Fig. 7.

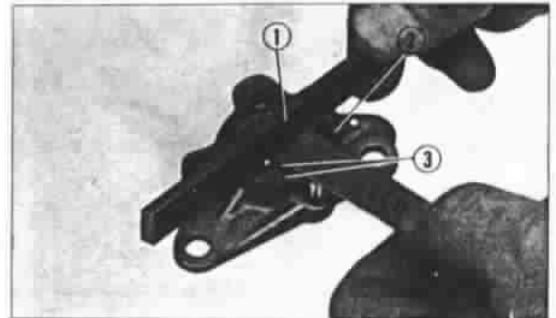

① Straight edge ② Pump body ③ Rotor
Fig. 8

D. Reassembly

Perform the reassembly in the reverse order of disassembly procedure. Particular attention should be paid to the following items (Fig. 9).

1. Make sure that the parts are thoroughly cleaned before assembly.
2. After completing the reassembly of the pump, check to make sure that the pump is operating smoothly by turning the shaft by hand before mounting the pump in the crankcase.

5. CYLINDER AND CYLINDER HEAD

A. Description

The cylinder head is made of aluminum alloy to improve the cooling effect. Cylinder is made of special cast iron which provides good wear characteristics without being affected by high temperature and pressure.

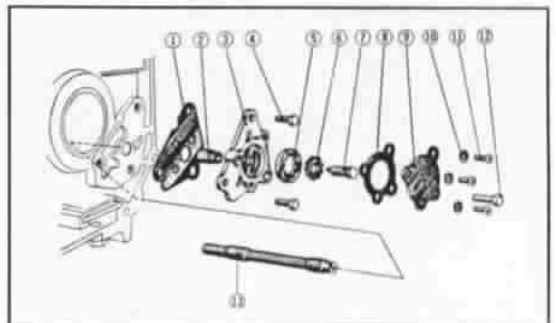

① Oil pump body gasket ② Oil pump dwell pin
③ Oil pump body ④ 6 mm hex. bolt
⑤ Oil pump outer rotor ⑥ Oil pump inner rotor
⑦ Oil pump drive shaft ⑧ Oil pump cover gasket
⑨ Oil pump cover ⑩ 5 mm spring washer
⑪ 5 mm cross screw ⑫ 6 mm hex. bolt
⑬ Cam chain guide sprocket spindle
Fig. 9

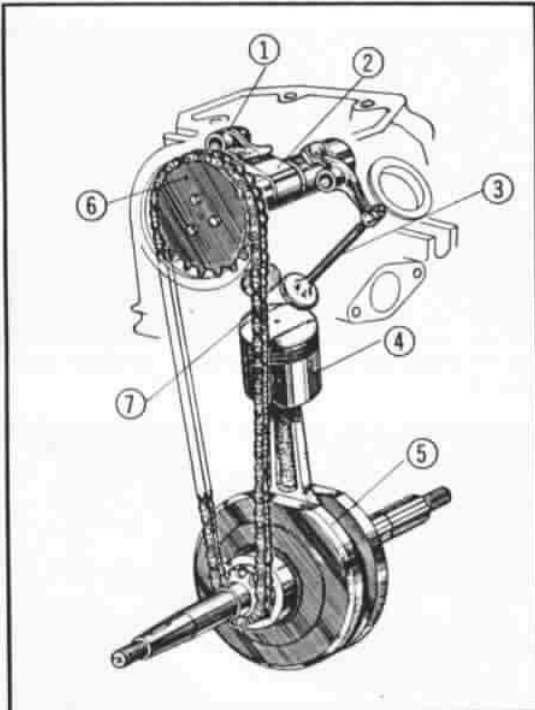

① Rocker arm ② Camshaft ③ Valve ④ Piston
⑤ Crankshaft ⑥ Cam sprocket ⑦ Camchain
Fig. 10

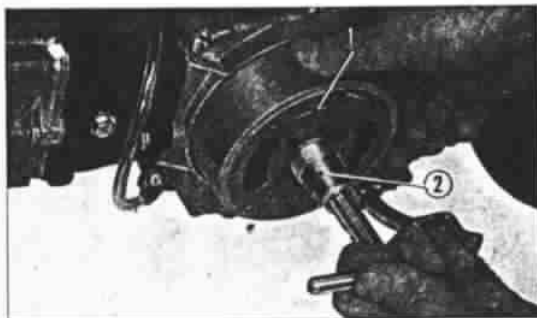

① Flywheel generator ② Flywheel puller
Fig. 11

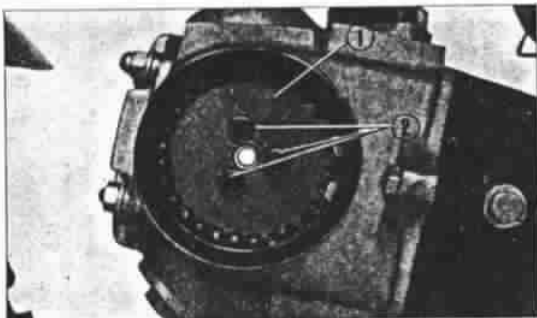

① Cam sprocket ② Sprocket setting bolts
Fig. 12

B. Disassembly

1. Drain the engine oil by removing the drain plug.
2. Unscrew the left crankcase cover mounting screws and remove the cover.

3. Remove the flywheel using the flywheel puller (Tool No. 07933-0010000) and then remove the stator assembly (Fig. 11).

4. Loosen the 6 mm hex bolt from the left cylinder head side cover and remove the side cover. Also loosen the two cross screws and remove the right cylinder head side cover.

5. Loosen the three cam sprocket mounting bolts and remove the cam sprocket from the camshaft (Fig. 12).

6. Unscrew the four cylinder head hold-down nuts and 6mm hex. bolt and then separate the cylinder head from the cylinder.

7. Loosen the cam chain guide roller pin and remove the cam chain guide roller from the cylinder (Fig. 13).
8. Unscrew the cylinder mounting bolt (1 each) and remove the cylinder.
9. Disassemble the valve rocker arm and the camshaft from the cylinder head.

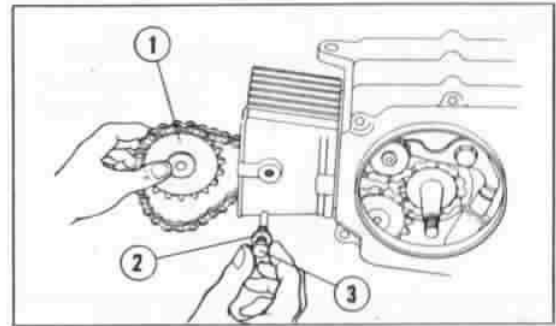

① Cam chain guide roller ② 8 mm sealing washer
③ Cam chain guide roller pin

Fig. 13

10. Disassemble the valve by using the valve removal tool (Tool No. 07957-3290000) (Fig. 14).

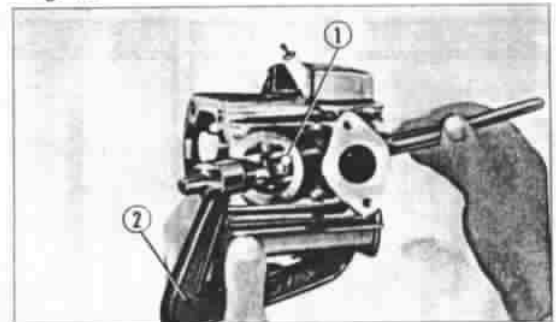

① Valve cotter ② Valve lifter

Fig. 14

C. Inspection

1. Inspecting the cylinder head machined gasketing surface.
Place a straight edge across the machined gasketing surface and measure the clearance between the straight edge and the machined surface with a thickness gauge. If the clearance is greater than 0.002 (0.05 mm), the cylinder head should be repaired or replaced.
To perform the repair, place a sheet of fine grit emery paper on the lapping or surface plate and rework the cylinder head. The condition of the machined surface can be checked by using prussian blue or red lead (Fig. 16).

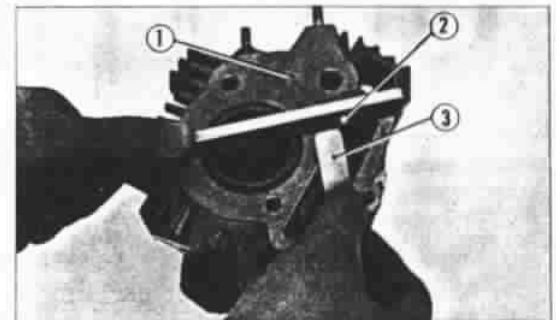

① Cylinder head ② Straight edge
③ Thickness gauge

Fig. 15

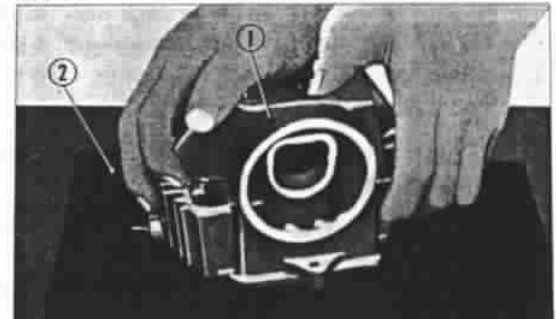

① Cylinder head ② Emery paper

Fig. 16

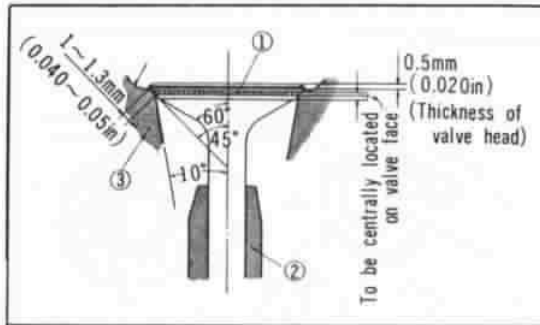

① Valve face contact area ② Valve guide
③ Cylinder head body
Fig. 17

2. Inspecting the valve seat

The standard width of the valve contact surface is 0.040-0.051 (1.0-1.3 mm). When the contact surface becomes wider than 0.080 (2.0 mm), the valve seat should be repaired with a seat cutter (included in the special tools). Valve seat is cut to the proper dimension using the valve seat top and interior cutters. The 90° seat cutter is used to repair the valve seat contact surface.

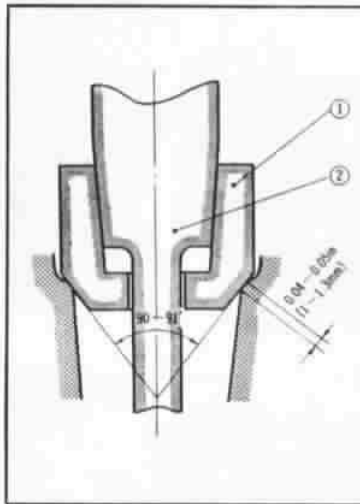

① Valve seat cutter 90°
② Valve seat cutter holder
Fig. 18A

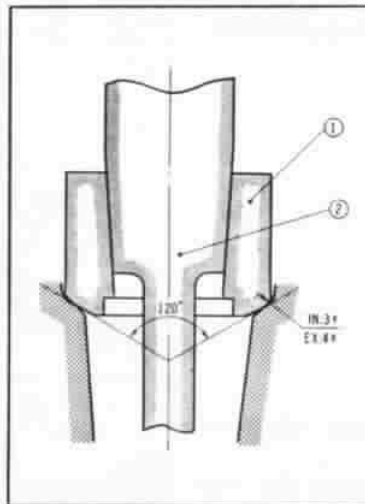

① Valve seat top cutter
② Valve seat cutter holder
Fig. 18B

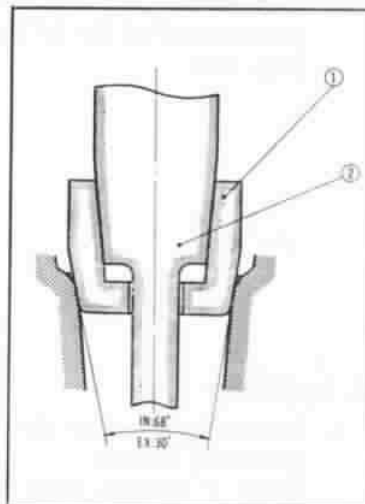

① Valve seat interior cutter
② Valve seat cutter holder
Fig. 18C

Whenever the valve seat has been repaired or the valve replaced, the valve must be lapped to the seat.

To lap the valve, apply a small amount of lapping compound to the valve contact surface and rotate the valve back and forth against the seat using a suction cup tool; lifting the valve off the seat occasionally. After the valve lapping is completed, wash off the lapping compound thoroughly from both the seat and face of the valve. Finally, check the seating of the valve with Prussian blue or red lead to assure that a good seat has been obtained.

Note :

1. Read carefully the instruction provided with the valve seat grinder. (Tool No. 07782-0020000, A set)
2. Apply a small amount of oil to the valve stem when inserting the valve into the guide.
3. After the valve has been assembled into the cylinder head, check the sealing of the valve by pouring a small quantity of engine oil into the combustion chamber until the valve heads are covered and then apply compressed air at 28.4 psi (2 kg/cm²) alternately into the inlet and exhaust ports and check for any bubbles arising from around the valve seats. If there are no bubbles, the valves are sealing properly.

3. Measuring the wear of the valve stem and valve guide.

Place a dial gauge against the valve stem and move the valve sideways, and fore and aft. The amount of wear in any direction will be indicated on the gauge (Fig. 19).

Item	Standard Value	Serviceable Limit
Inlet	0.0004~0.0012 (0.01~0.03 mm)	Replace if over 0.0032 (0.08 mm)
Exhaust	0.0012~0.002 (0.03~0.05 mm)	Replace if over 0.004 (0.10 mm)

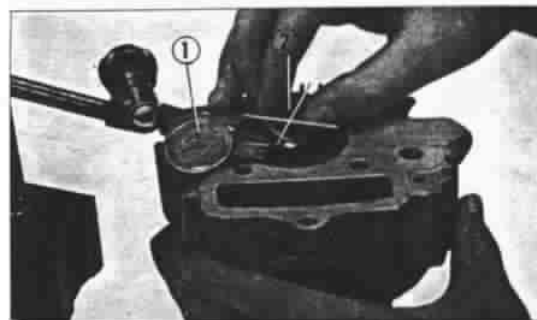

① Small dial gauge ② Valve
Fig. 19

4. Measuring the valve dimension

The valve stem diameter is measured with a micrometer. (Fig. 20)

Item	Standard Value	Serviceable Limit
Inlet	0.2148~0.2187 (5.455~5.465 mm)	Replace if under 0.2126 (5.40 mm)
Exhaust	0.2070~0.2109 (5.435~5.445 mm)	Replace if under 0.2048 (5.38 mm)

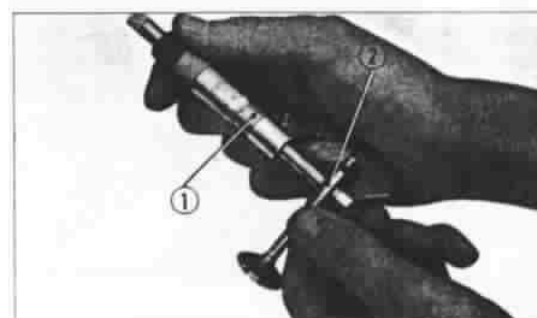

① Micrometer ② Valve
Fig. 20

5. Replacing the valve guide

If the valve guide is worn excessively and requires replacement, follows the procedure below.

- a. Remove the valve guide from the cylinder head using the valve guide remover (Tool No. 07942-3290100).
- b. Install the new valve guide using the valve guide driver (Tool No. 07942-3290200), and carefully drive the guide into the head. The replacement valve guide should be one that is of an oversize.
- c. After the new valve guide has been installed, it must be reamed to the proper finish size using a guide reamer (Tool No. 07984-0980000). Exercise care when using the reamer and apply small amount of oil occasionally to lubricate when the reamer starts to operated hard. pull out the reamer and remove the metal chip before continuing to ream. The standard valve guide diameter is 0.2156-0.2159 (5.475-5.485 mm). Measurement can be made with a cylinder gauge (Fig. 22).

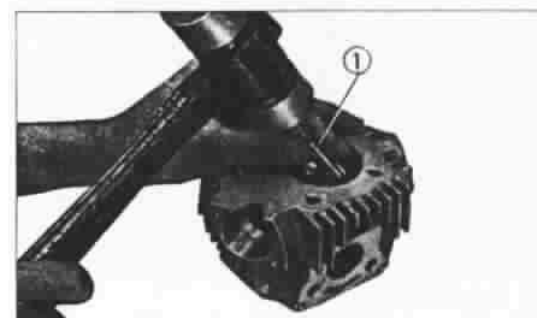

① Valve guide remover
Fig. 21

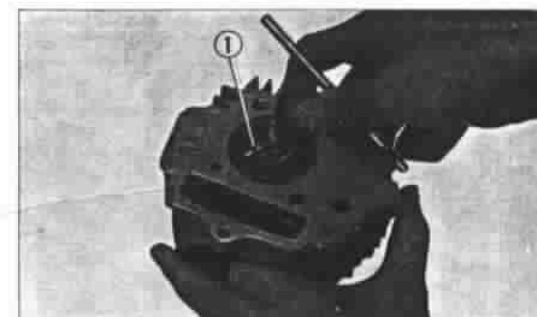

① Valve guide reamer
Fig. 22

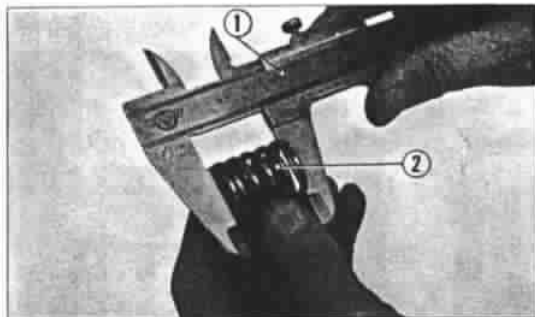

① Vernier caliper ② Valve spring
Fig. 23

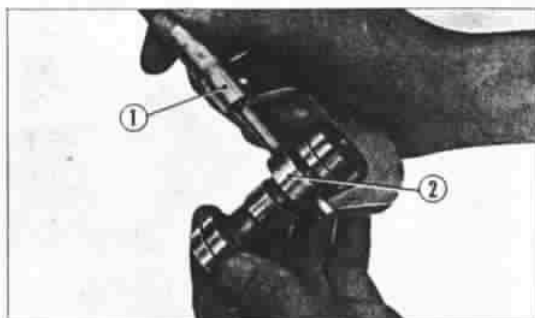

① Micrometer ② Camshaft
Fig. 24

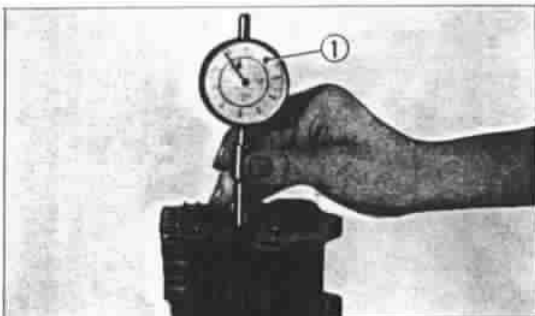

① Cylinder gauge
Fig. 25

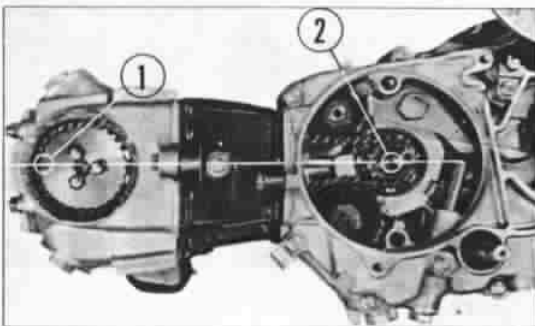

① "O" mark ② Key
Fig. 26

6. Inspecting the valve spring

Measure the length of the valve spring free length with a vernier caliper.

Standard Value	Serviceable Limit
1.11 (28.1 mm)	Replace if under 1.06 (26.9 mm)

7. Inspecting the camshaft

Measure the cam lift with a micrometer

Item	Standard Value	Serviceable Limit
Base circle	0.825 (21.0 mm)	Replace if under 0.819 (20.8 mm)
Cam lift (including the base circle)	1.025 (26.076 mm)	Replace if under 1.015 (25.8 mm)

8. Measuring the inside diameter of the cylinder

Use a cylinder gauge and measure the inside diameter of the cylinder at the top, center and bottom in both the X and Y axes. If the cylinder is excessively worn, it should be either rebored or replaced with a new cylinder depending upon the extent of wear (Fig. 25).

Standard Value	Serviceable Limit
1.5358~1.5362 (39.01~39.02 mm)	39.1 (1.540 mm)

Note :

When reboring the cylinder, it must be rebored to an oversize units of 0.010 (0.25 mm) up to a maximum of 0.40 (1.0 mm) since the piston and the piston ring sets comes in those oversizes only.

D. Reassembly

Perform the reassembly in the reverse order of disassembly which was described in page 9 section B, however, follow the procedure below for timing the valves.

Position the key of the left crankshaft so that it is pointing toward the cylinder head, and position the cam that the "O" marking on the cam sprocket is at the topmost position (Fig. 26).

Note :

1. When installing the cylinder head, the cam sprocket must be contained within the cylinder head (Fig. 27).
2. Make sure that the respective gaskets, dowel pins and rings have not been overlooked.

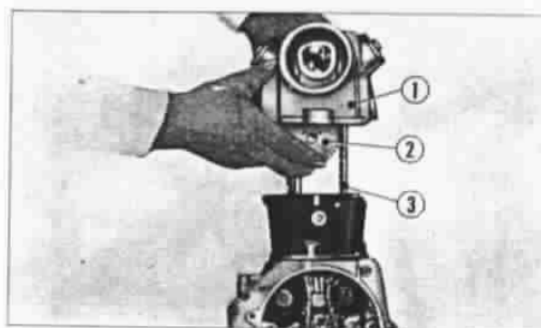

① Cylinder head ② Cam sprocket ③ Cam chain
Fig. 27

3. When torquing down the cylinder head, tighten the nuts uniformly in a diagonal sequence as shown in the Fig. 28 and torque to the final specified torque value of 6.5-9 ft-lb (90-120 kg-cm).

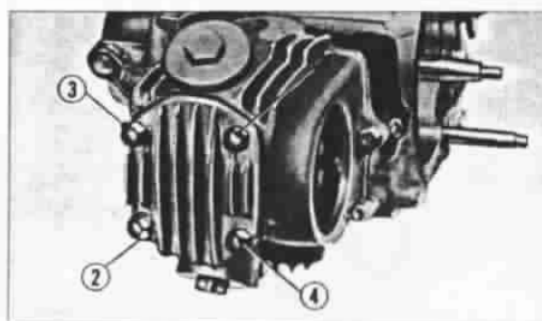

Fig. 28 Torquing sequence

6. PISTON AND PISTON RINGS

A. Description

The piston is made of special SAE 332 aluminum alloy to minimize material deformation caused by high temperature and also because of its good wear resistant qualities. The piston rings especially should be highly resistant and therefore, they are hard chrome plated or wet honed to give it the desired characteristics.

B. Disassembly

1. The piston is disassembled from the connecting rod by first removing the piston pin clip and then the piston pin (Fig. 29).

Note :

When removing the piston pin clip, place a rag under the piston so that the clip will not fall into the crankcase if it should accidentally be dropped.

2. To remove the piston rings from the piston, it is recommended that the piston ring remover be used, however, if one is not available, they can be removed by hand, but care should be exercised so that they are not broken.

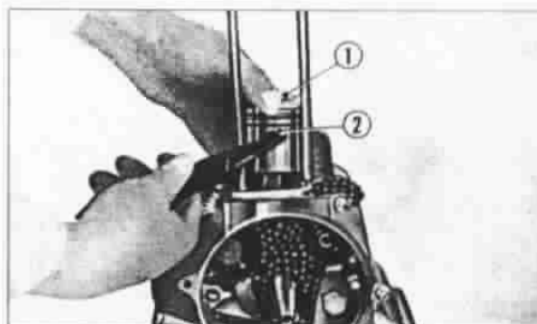

① Piston ② Piston pin clip
Fig. 29



① Micrometer ② Piston diameter
Fig. 30

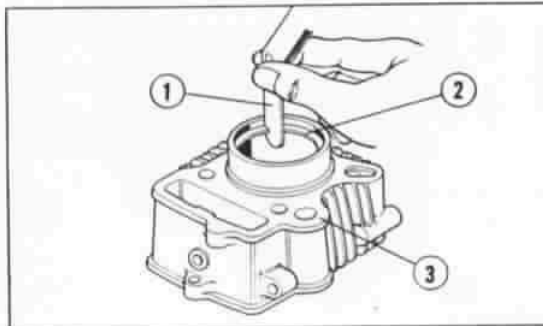

① Thickness gauge ② Piston ring ③ Cylinder
Fig. 31

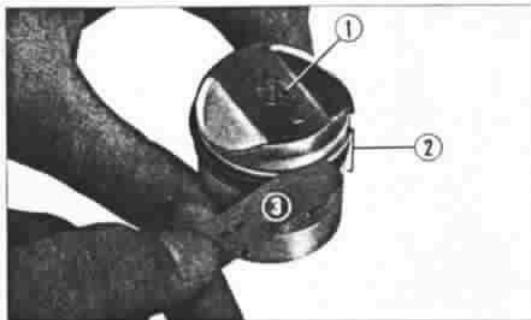

① Piston ② Piston rings ③ Thickness gauge
Fig. 32

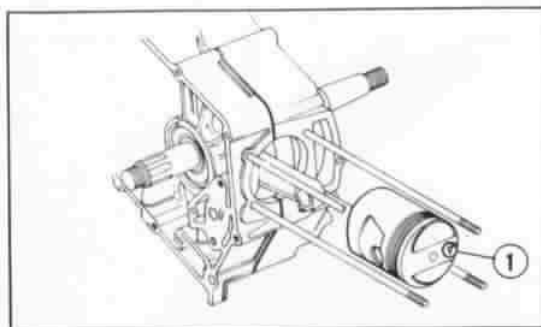

① Arrow mark
Fig. 33

C. Inspection

1. Measuring the piston

Measure the piston diameter at the piston skirt at right angle to the piston pin axis using a micrometer (Fig. 30).

Standard Value	Serviceable Limit
1.5346~1.5354 (38.98~39.00 mm)	Replace if under 1.73 (38.88 mm)

2. Measuring the piston ring end gap

Insert the piston ring into the cylinder skirt and measure the ring end gap with a thickness gauge (Fig. 31).

Standard Value	Serviceable Limit
0.004~0.012 (0.1~0.3 mm)	Replace if over 0.02 (0.5 mm)

Note :

For preventing damage to the piston ring the piston is an available and convenient tool to insert the ring into the cylinder.

3. Measuring the piston ring side clearance

Measure the clearance between the piston ring and piston land with a thickness gauge (Fig. 32).

Item	Standard Value	Serviceable Limit
Top and second rings	0.0006~0.0018 (0.015~0.045 mm)	Replace if over 0.0039 (0.1 mm)
Oil ring	0.0004~0.0018 (0.010~0.045 mm)	Replace if over 0.0039 (0.1 mm)

4. Piston and piston ring are available in four standard oversizes of 0.01 (0.25 mm) up to 0.04 (1.0 mm)

D. Reassembly

Perform the reassembly in the reverse order of disassembly as described on page 9~10 and 13~14.

Note :

When assembling the piston to the connecting rod, make sure that the arrow marked on the piston head is pointing downward. (Fig. 33)

7. CLUTCH

A. Description

The clutch is a wet multiple disc, automatically engaging, centrifugal type. The gear change operation can be performed smoothly since the gear change mechanism is interconnected with the clutch pedal and when the clutch pedal is depressed, the ball retainer will be activated and causes the clutch to disengage.

As the engine speed increases the rollers are forced outward by the centrifugal force causing the clutch plate and friction disc to engage, permitting the power from the crankshaft to be transmitted to the transmission (Fig. 34).

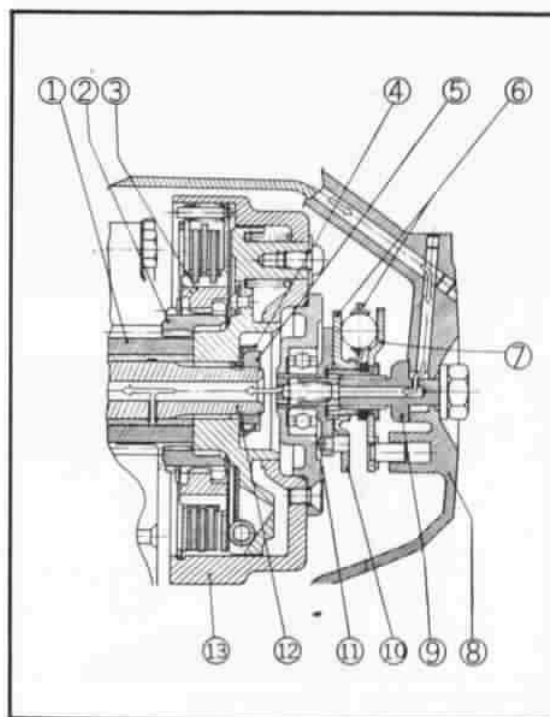

- ① Primary drive gear ② Drive outer
- ③ Clutch center ④ 14 mm lock washer
- ⑤ 14 mm lock nut ⑥ Ball retainer complete
- ⑦ Clutch lifter plate ⑧ Right crankcase cover
- ⑨ Clutch adjusting bolt ⑩ Clutch complete
- ⑪ Clutch outer cover ⑫ Crankshaft
- ⑬ Clutch outer

Fig. 34

B. Disassembly

1. Loosen the right crankcase cover retaining screws and remove the cover.
2. Remove the clutch outer cover.
3. Straighten the tab on the lock washer and by using the clutch outer holder (Tool No. 07923-0350000) and lock nut wrench (Tool No. 07916-0010000), loosen the lock nut and remove the clutch assembly (Fig. 35).

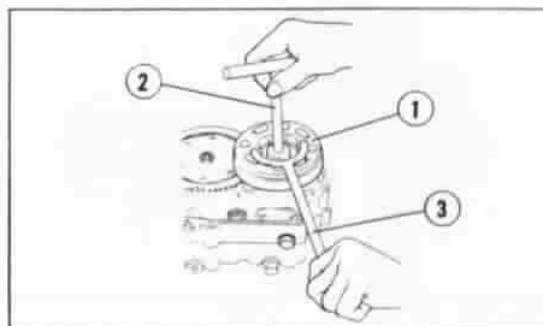

- ① Clutch outer ② Lock nut wrench
- ③ Clutch outer holder

Fig. 35

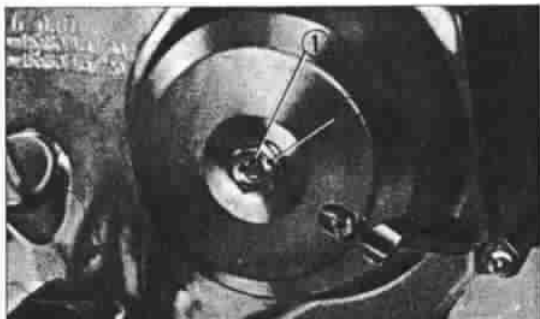

① Clutch adjuster ② Lock nut
Fig. 36

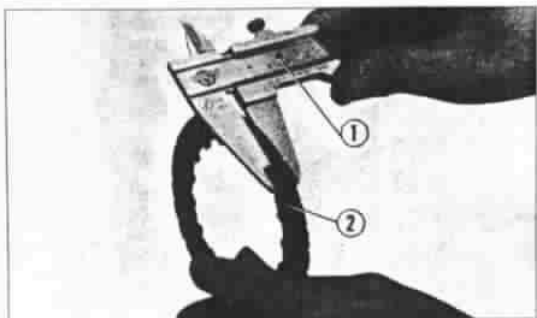

① Vernier caliper ② Friction disc
Fig. 37

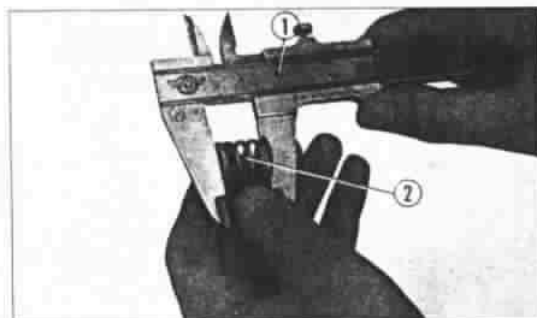

① Vernier caliper ② Clutch spring
Fig. 38

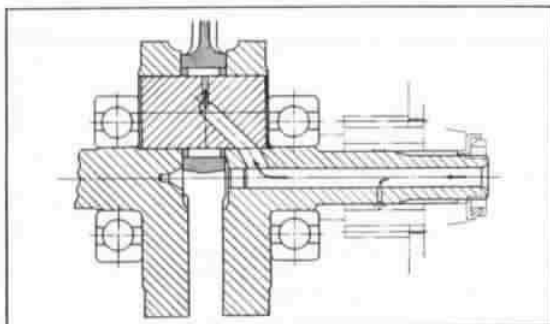

Fig. 39 Oil flow

C. Inspection

1. Clutch adjustment.

- Clutch must be adjusted with the engine shut off. Loosen the adjuster lock nut.
- Turn the adjuster clockwise about one turn; do not turn excessively.
- Next, slowly turn the adjuster counterclockwise and stop when the adjuster to turn heavy.
- From this point, back off the adjuster in the clockwise direction $\frac{1}{8}$ to $\frac{1}{4}$ turn, and tighten the lock nut (Fig. 36).

Check to make sure that the clutch operates properly after adjustment.

- The engine should start easily with the kick starter without the clutch slipping.
- When changing gear, the clutch slipping should be smooth and light, especially when shifting down in gear to the neutral position.

2. Measuring the friction disc

Measure the thickness of the friction disc using a vernier caliper (Fig. 37).

Standard Value	Serviceable Limit
0.138 (3.50 mm)	Replace if under 0.122 (3.10 mm)

3. Inspecting the clutch spring

Measure the free length of the spring using a vernier caliper (Fig. 38).

Standard Value	Serviceable Limit
0.772 (19.6 mm)	Replace if under 0.72 (18.2 mm)

D. Reassembly

Perform the reassembly in the reverse order of disassembly as described in page 16.

8. CRANKSHAFT

A. Description

The connecting rod is assembled on the crank pin. The bearing at the large end is lubricated by the pressurize oil which flows through the crankshaft (Fig. 39).

B. Disassembly

1. Remove the cylinder head and cylinder in accordance with the procedure described on page 9~10.
2. Remove the clutch assembly in accordance with the procedure described on page 16.
3. Remove the primary driven gear and the kick starter spring.
4. Remove the oil pump.
5. Remove the gear shift stopper and plate.
6. Loosen the left crankcase cover screws and then remove the cover, flywheel, stator and the cam chain.
7. Pull off the rubber plug and remove the gear shift drum stopper bolt.
8. Remove the final drive sprocket.
9. Remove the right crankcase.
10. Lift out the crankshaft assembly from the case.

C. Inspection

1. Measuring the crankshaft balance
Support the crankshaft on V-blocks at the bearings. Rotate the crankshaft and measure the amount of runout at both ends of the crankshaft using a dial gauge (Fig. 40).

Item	Standard Value	Serviceable Limit
Left end, at 1.2 (30 mm) from the weight	0.0006 (0.015 mm)	Repair if over 0.002 (0.05mm)
Right end, at 1.0 (25 mm) from the weight		

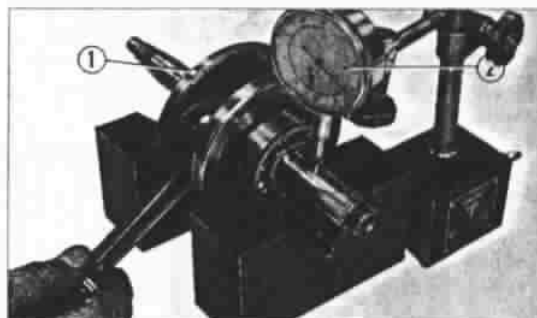

① Crankshaft ② Dial gauge
Fig. 40

2. Measuring the connecting rod side play.
Measure the amount of connecting rod side play using a thickness gauge (Fig. 41).

Standard Value	Serviceable Limit
0.004~0.014 (0.1~0.35 mm)	Replace if over 0.0315 (0.80 mm)



① Crankshaft ② Connecting rod
③ Thickness gauge
Fig. 41

3. Measuring the radial clearance of the connecting rod large end bearing.
Measure the amount of clearance at the connecting rod large end by using a dial gauge (Fig. 42).

Standard Value	Serviceable Limit
0.0005 max. (0.012 mm max.)	Replace if over 0.002 (0.05 mm)

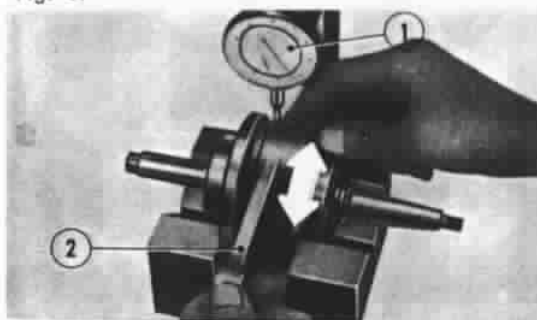

① Dial gauge ② Connecting rod
Fig. 42

D. Reassembly

Perform the reassembly in the reverse order of disassembly.

9. TRANSMISSION

This motorcycle use a constant mesh three speed transmission.

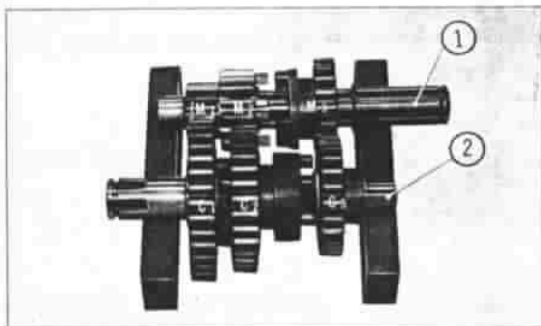

① Transmission mainshaft
② Transmission countershaft
Fig. 43-A Neutral position

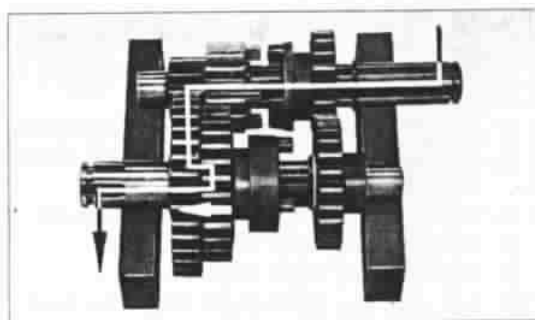

Fig. 43-B Low gear (C_2 shifted)

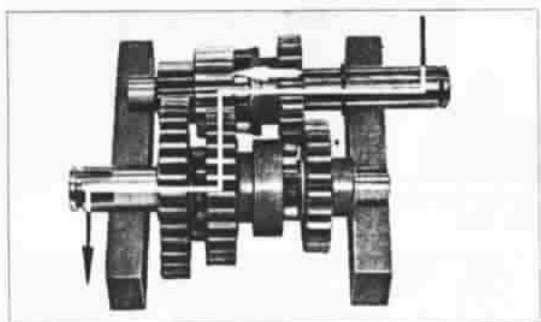

Fig. 43-C 2nd gear (M_2 shifted)

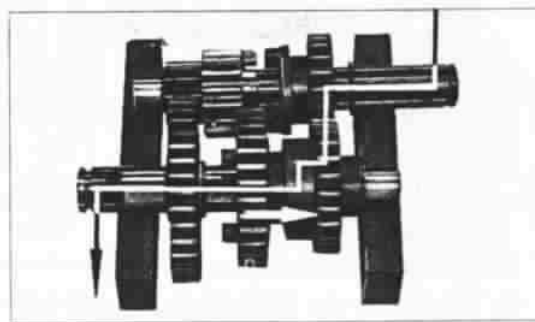
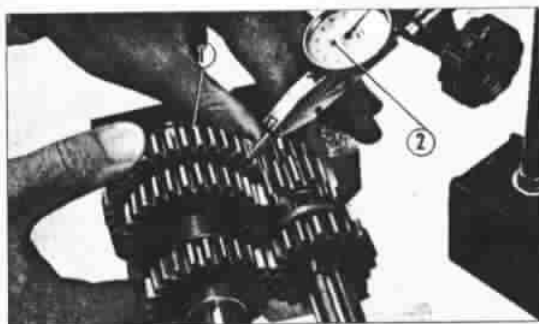

Fig. 43-D Top gear (C_2 shifted)

B. Disassembly

Perform the disassembly in accordance with the description in the section on crankshaft disassembly on page 18.

Remove the right crankcase and then remove the mainshaft, countershaft gear assembly and the gear shift fork assembly together as the unit.



① Gear ② Small dial gauge
Fig. 44

C. Inspection

1. Measuring the gear backlash

Lock one gear of the gear set being measured and measure the amount of gear movement in the free gear using a dial gauge (Fig. 44).

Item	Standard Value	Serviceable Limit
Low gear	0.0033~0.0067 (0.085~0.169 mm)	Replace if over 0.010 (0.25 mm)
2nd gear	0.0035~0.0071 (0.089~0.179 mm)	Replace if over 0.010 (0.25 mm)
Top gear	0.0033~0.0067 (0.084~0.170 mm)	Replace if over 0.010 (0.25 mm)

2. Wear of the gears

When the gears has been used over a long period, the gear teeth and the dog will wear and will also tend to make contact on the side, producing noise and causing the dog slip out. Under such condition, the gears should be replaced in sets for satisfactory performance.

3. Measuring clearance between the gear and shaft

Measure the diameter of the gear shaft bore with a cylinder gauge or inside micrometer and measure the shaft diameter with a micrometer. From the two value compute the clearance.

Gears	Standard Value	Serviceable Limit
Mainshaft	0.0009~0.0024	Replace if over 0.0039 (0.10 mm)
2nd gear	(0.022~0.060mm)	
Countershaft low and top gears	0.0012~0.0030 (0.032~0.077 mm)	Replace if over 0.0039 (0.10 mm)

(Reference)

Item	Standard Value
Gear shaft bore	0.6699~0.6709 (17.016~17.043 mm)
Mainshaft diameter	0.6686~0.6690 (16.983~16.994 mm)
Countershaft diameter	0.6679~0.6686 (16.966~16.984 mm)

4. Checking the operation of the respective gears

Shift the gears into the neutral position and check to make sure that all of the gears rotate smoothly or slide smoothly.

D. Reassembly

Perform the reassembly in the reverse order of disassembly. Exercise care on the following points.

1. Assemble the respective gears, washers and circlips properly in the accordance with Fig. 45.
2. Replace all circlips with new items.

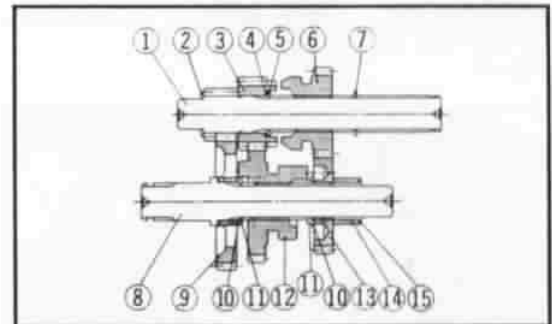

- ① Transmission mainshaft ② Thrust washer
③ Mainshaft second gear ④ 17 mm spline washer
⑤ 17 mm circlip ⑥ Mainshaft top gear
⑦ 17 mm circlip ⑧ Transmission countershaft
⑨ Countershaft low gear ⑩ 17 mm spline washer
⑪ 17 mm circlip ⑫ Countershaft second gear
⑬ Countershaft top gear ⑭ Gear collar
⑮ 13.5 mm thrust washer

Fig. 45

10. GEAR SHIFT MECHANISM

A. Description

The gear spindle arm which is connected to the gear shift spindle rotates the gear shift drum and this causes the gear shift fork to move left and right in the drum groove. The gear shift fork is controlled by the groove in the drum and this in turn causes the gears to slide and change gears.

B. Disassembly

1. Refer to the section on disassembly of the crankshaft assembly on page 18.
By removing the right crankcase, the gear shift drum and the fork assembly can be removed together with the transmission gear as a complete unit.

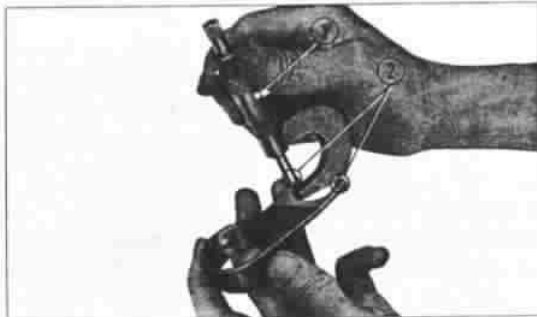

① Micrometer ② Gear shift fork ends
Fig. 46

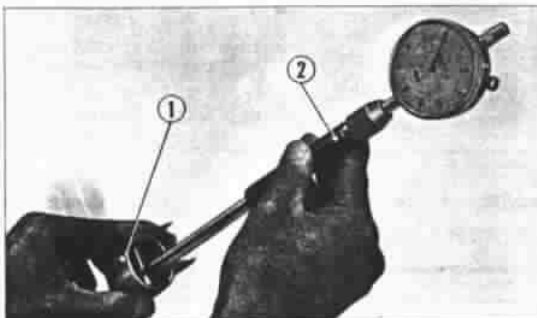

① Gear shift fork ② Cylinder gauge
Fig. 47

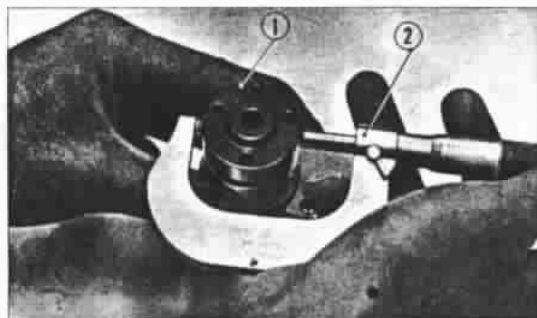

① Gear shift drum ② Micrometer
Fig. 48

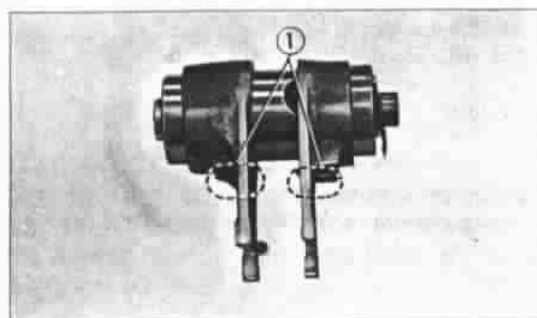

① Guide pin clip
Fig. 49

C. Inspection

1. Measuring thickness of the gear shift fork ends

The thickness of the shift fork end is measured with a micrometer (Fig. 46).

Standard Value	Serviceable Limit
0.191~0.195 (4.86~4.94 mm)	Replace if under 0.181 (4.6 mm)

2. Measuring the inside diameter of the gear shift fork

The inside diameter of the gear shift fork is measured with a cylinder gauge or an inside micrometer (Fig. 47).

Standard Value	Serviceable Limit
1.3385~1.3395 (34.0~34.025 mm)	Replace if over 1.346 (34.2 mm)

3. Measuring the outside diameter of the gear shift drum

The diameter is measured with a micrometer (Fig. 48).

Standard Value	Serviceable Limit
1.3366~1.3377 (33.95~33.98 mm)	Replace if under 1.335 (33.9 mm)

D. Reassembly

Perform the reassembly in the reverse order of disassembly. Exercise care on the following points.

Make sure that the guide pin and guide pin clip are properly installed on the gear shift drum for both the right and left shift forks (Fig. 19).

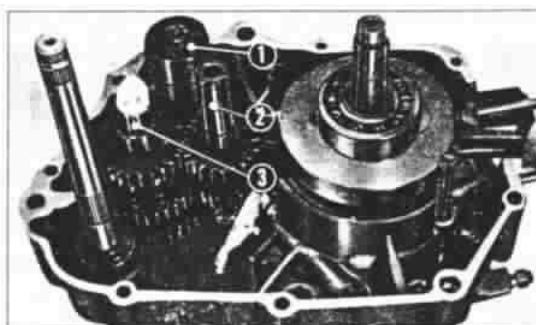

① Gear shift drum ② Mainshaft ③ Countershaft
Fig. 50

11. KICK STARTER

A. Description

When the kick starter is operated, the kick starter spindle will rotate counterclockwise. The kick starter pinion being engaged to the countershaft low gear transmits the rotary force to the crankshaft through main shaft. When the kick pedal is released the kick starter pinion disengages from the low gear and there is no longer the transmission of force (Fig. 51).

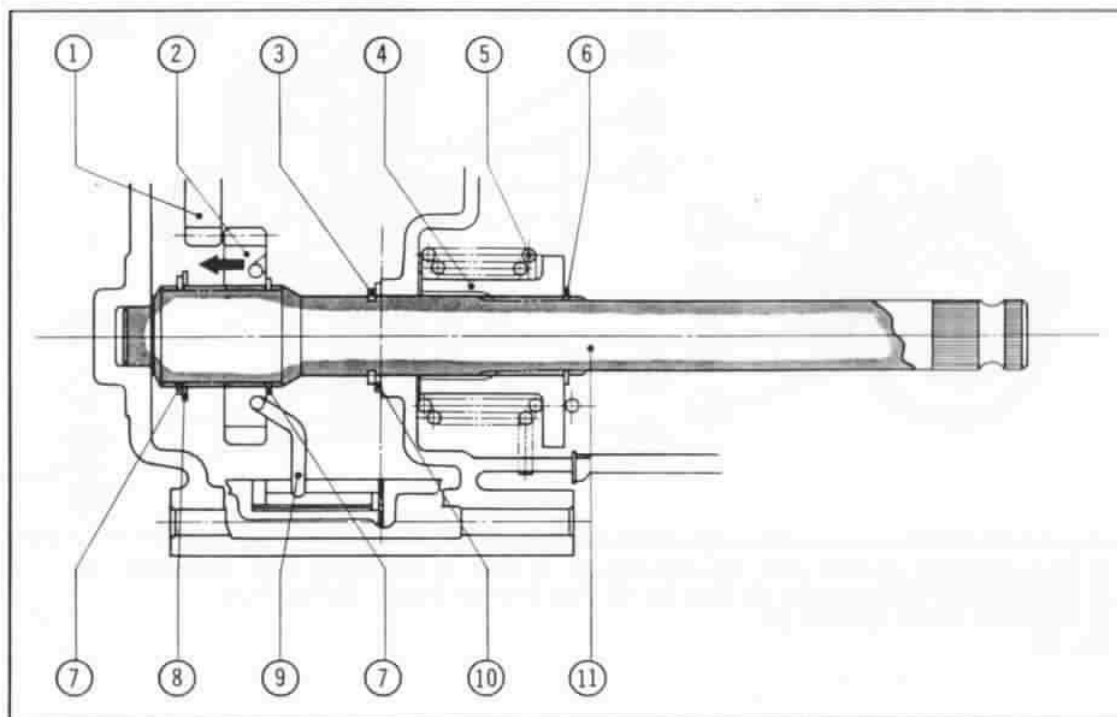

① Countershaft low gear ② Kick starter pinion ③ 17 mm circlip ④ Kick spring retainer
⑤ Kick starter spring ⑥ 16 mm circlip ⑦ 20 mm set ring ⑧ 20 mm washer ⑨ Kick starter ratchet spring
⑩ 17 mm thrust washer ⑪ Kick starter spindle
Fig. 51

B. Disassembly

1. Refer to the section on disassembly of the crankshaft on page 18.

By removing the right and left crankcases, the kick starter spindle assembly can be removed.

C. Inspection

Check to make sure that the kick starter pinion is operating smoothly.

D. Reassembly

1. Perform the reassembly in the reverse order of the disassembly.

12. CARBURETOR**A. Description**

The carburetor mixes the fuel and air taken into the engine in a correct proportion to produce a mixture and which is further atomizes so that it is easily combustible. The construction of the carburetor is shown in Fig. 52.

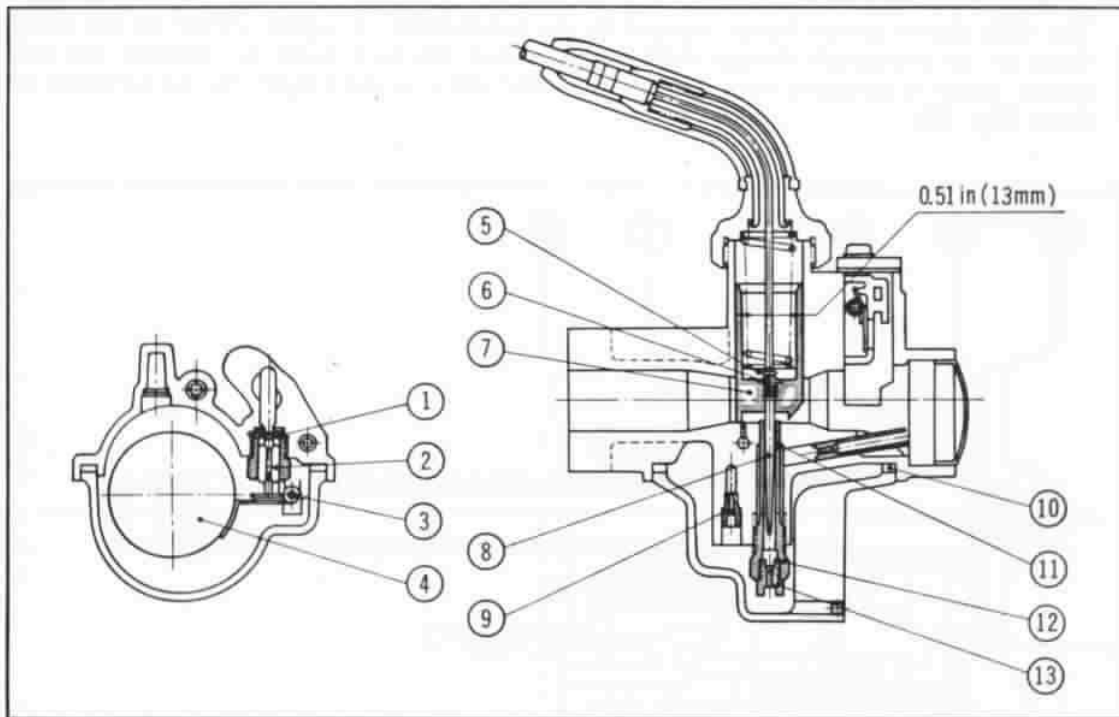

① Float valve seat ② Float valve ③ Float arm pin ④ Float ⑤ Needle clip plate ⑥ Needle clip
 ⑦ Throttle valve ⑧ Jet needle ⑨ Slow jet ⑩ Float chamber washer ⑪ Needle jet
 ⑫ Needle jet holder ⑬ Main jet

Fig. 52

Item		Specification
Setting mark		Z50M II
M.J. (Main Jet)		# 50
A.J. (Air Jet)		# 100
A.B. (Air Bleed)	AB 1	0.5 × 2
	AB 2	—
	AB 3	—
	AB 4	0.5 × 2
	AB 5	0.5 × 2
N.J. (Needle Jet)	2.1 mm (0.083 in.) × 3R	
J.N. (Jet Needle)	2°, 2 Steps, 2.05 mm (0.0907 in.)	
C.A. (Cut away)	# 2 (Cut away), Width 1 mm (0.0394 in.) Depth 0.2 mm (0.0079 in.)	
A.S. (Air Screw)	1 $\frac{3}{8}$ ± $\frac{1}{8}$	
P.J. (Pilot Jet)	# 38	
V.S. (Valve Seat)	0.6 mm (0.024 in.)	
B.P. (By-pass)	0.9 mm (0.035 in.) P = 5.3 mm (0.209 in.)	
Main Bore	9 mm (0.354 in.)	
Fuel Level	18 mm (0.709 in.)	

B. Removal

1. Turn the fuel cock to the OFF position and disconnect the fuel tube from the carburetor.
2. Remove the cap and disconnect throttle cable from the throttle valve.
3. Unscrew the two carburetor mounting bolts to remove the carburetor.
4. Loosen the air cleaner tube connecting clamp and separate the air cleaner assembly from the carburetor.
5. Remove air cleaner cover and lift out the air cleaner element.

C. Inspection

1. Washing the components
After the carburetor has been disassembled, wash the parts in solvent (or gasoline) and dry with compressed air.
2. Inspecting the float
Shake the float to see if there are any gasoline contained inside or for any deformation of the float. If the float contain the gasoline or is deformed, replace it with a new float.
3. Carburetor adjustment
 - a. Adjusting the idle
The idling is adjusted in the following manner with the throttle stop screw and the air screw.
 - (1) Sets the engine to the proper idling speed (1200 rpm) with the throttle stop screw.

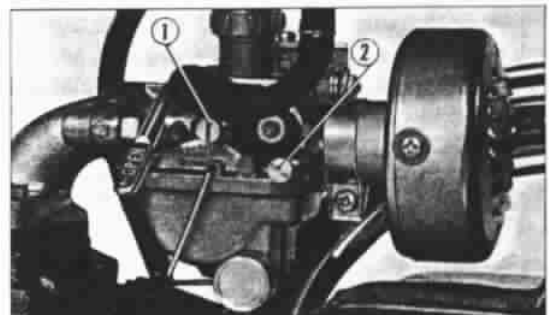

① Throttle stop screw ② Air screw
Fig. 53

- (2) Next turn the air screw slowly back and forth to obtain the point of the highest rpm.
- (3) If the engine rpm has increased as result of section (2) above, reset the engine speed back to the proper rpm with the throttle stop screw.
- (4) Once again manuplate the air screw to see if the rpm will be increased.
- (5) If the speed should increase again, perform section (3) (4) above again.

However, the adjustment of the air screw should be within $1\frac{3}{8} \pm \frac{1}{8}$ of a turn.

b. Adjusting the slow speed

The fuel mixture adjustment between idle to $\frac{1}{8}$ throttle opening is made by the air screw and the cut away on the throttle valve.

(1) Air screw

Turning in the clockwise direction will produce a rich mixture.

(2) Throttle valve cut away

In the vicinity $\frac{1}{8}$ throttle opening, there may be cases where the fuel mixture cannot be adjusted by the air screw only. In such case, if the fuel mixture is too rich, the throttle valve must be replaced with one having a cutaway of a large number size and then readjust the air screw.

c. Adjusting intermediate speed

At the throttle opening range between $\frac{1}{8}$ - $\frac{3}{4}$ the fuel mixture adjustment is made primary by the position of the jet needle steps and replacement of the cut away of the throttle valve. However, changing the cutaway of the throttle valve will also affect the throttle opening between the $\frac{1}{4}$ to $\frac{1}{16}$, therefore, the adjustment of the intermediate speed by replacing the throttle valve cut away only is very difficult. It is recommended that the adjustment for the intermediate speed be made by the jet needle, and stay within the range of acceptable acceleration performance since this would provide greater fuel economy.

d. Adjusting the high speed

While driving at high speed, if the speed increases when the choke is closed slightly, it is an indication that the carburetor is set too lean. Progressively replace the main jet with one of a large size and readjust the carburetor.

Note: Main jet sizes are numbered in the following manner:

Above #100: 105, 110, 115

Below #100: 98, 95, 92, 90

If the speed drops when the choke is closed slightly, it indicates that the main jet is either of the proper size or that it is too large, in which case, perform the following check to make the determination.

o Proper jet size

Progressively replace the main jet with one of a smaller size until there is a drop in speed and the speed increases when the choke is closed slightly, the installed jet is too small and should be replaced with one of a size larger, this is the proper jet size.

TROUBLE SHOOTING CHART

(CARBURETOR)

Troubles	Probable Cause	Remedy	Procedure
Engine will not start	Fuel cock in the closed position.	Position cock to the open position.	
	Insufficient fuel.	Pour fuel or position cock to RES position.	
	Excessive use of choke has resulted in carburetor flooding.	Clean spark plug	Perform starting with the choke lever opened and the throttle at full open.
	Clogged or frozen fuel line.	Clean	<ul style="list-style-type: none"> • Clogged air vent icing condition, dirt clogged in valve. • Clean water which has accumulated in the float chamber (exercise care if water is frozen). • Condition outside of the carburetor will be clogged tank vent, strainer clogged with dirt or ice, clogging of the fuel lines.
	Flooding	Repair	Refer to section on flooding.
Poor idling performance	Readjust air screw	Adjust	Turn the air screw in all the way lightly and then back off to the standard setting of 1-3/8 open. Start the engine and turn the air screw back and forth approximately 1/8 turn to locate the point where the engine speed is the highest. Finally, set the idle speed with the throttle stop screw
	Throttle stop screw	Adjust	Turning screw in will result in increased engine speed. Turning screw out will result in decreased engine speed. When turning screw out will not effect decrease in engine speed, adjust with the cable adjuster.
	Clogged slow jet or loosened jet	Clean or retighten the jet.	When slow jet is clogged, disassemble the carburetor, remove the screw and clean out with compressed air.
	Carburetor flooding	Repair	Refer to section on flooding
Poor intermediate speed performance	Clogged slow jet or loosened jet.	Clean or retighten the jet.	Refer to section above
Not able to operate at cruising speed	Clogged air vent pipe	Clean	Remove the air vent pipe and clean.
	Float level	Adjust float level	If needle valve is worn, replace with a new part.
	Improper setting of the jet needle	Adjust if necessary	Normally set the needle to the third step, however, there may be a difference of one step for winter and summer.

Troubles	Probable Cause	Remedy	Procedure
Poor high speed performance	Choke left in closed position	Open choke full	Set the choke lever to open.
	Fuel lever cock	Set to open or RES	Position the lever to one of the position.
	Clogged air vent	Clean	Remove and clean.
	Clogged main jet	Clean	Remove the main jet and clean out with compressed air before assembly.
	Dirty air cleaner	Clean or replace	
Overflow	Clogged float valve with dust	Clean	Remove the float chamber cover. If there are accumulated dust, remove dust by blowing air or remove the valve seat and clean it.
	Damaged or worn valve and valve seat	Replace as assembly	Replace as valve assembly
	Punctured float	Replace	Remove the float and shake to check if fuel is inside. replace.
	Clogged air vent	Clean	

(ENGINE)

Troubles	Probable Cause	Remedy	Procedure
Poor speed and powerless	Clutch slippage	Check and adjust	If the clutch friction disk is worn beyond serviceable limit, replace the parts with new. Also check its corresponding parts. See page 18.
	Air cleaner and tube	Check and clean	When the air cleaner element and air inlet tube are clogged, clean the element by air and remove the dust inside inlet tube.
	Ignition timing, tappet clearance and engine's knocking	Adjust and correct	Align the "F" mark on the flywheel to the index mark on the case. The contact breaker point should just begin to open this time. Correct the proper tappet clearance by using a thickness gauge.
	Compression pressure	Inspect, retighten and replace	Measure compression pressure by gauge. If gauge show less than 8.0 kg/cm ² . Replace the piston ring and others. Retighten the cylinder and cylinder head bolts.
	Spark plug	Clean or replace	Clean spark plug electrode using a stiff wire and adjust the electrode gap (0.024-0.028 in or 0.6-0.7 mm), or replace the proper heat range plug.

Troubles	Probable Cause	Remedy	Procedure
	Lubrication	Pour or change oil	Shortage of oil amount or inferior oil cause engine seazing and stick. Supply proper grade oil or change if necessary.
	Fuel	Check	Premium quality gasoline is being used.
High oil consumption	① Wear of engine's part	Replace	Worn piston, piston ring and cylinder should be replaced
	② Clearance between valve and valve guide	Replace	Replace both valve and valve guide in case there are large clearance between them.
	③ Piston ring installation	Disassembling and inspect	Each piston ring must be installed properly on the piston and piston ring gaps must be staggered at 120° apart.
	④ Amount of oil	Check	When the oil was overfilled, drain the oil to bring to the proper oil level.
	⑤ Leakage	Check	Replace the gasket or oil seal and retighten the screws.

(CLUTCH MULFUNCTION)

Troubles	Probable Cause	Remedy	Procedure
Clutch slippage	Wear clutch plate and clutch friction disk and spring damage	Check and repair	Spring compressive force and free length are beyond the servicable limit, they should be replaced. Replace the parts in case the clutch disks and plates are distorted or excessively worn.
Clutch stick	Oil and defective installation	Inspect and adjust	Readjust the clutch or replace the clutch disks and plates if necessary.
Chattering noise	Clutch spring	Check and adjust	Adjust the same height of clutch spring and replace if the springs are distorted.
Gear shift operation			
Not able to shift the gear	Gear, shift fork, shift arm, spring	Inspect and replace	① Broken, wear and damage of these parts should be replaced. ② Repair the gear shaft arm or drum if they do not operate smoothly.
Gear change pedal does not return to the normal position	Gear shift return spring and gear shift arm spring	Inspect	① Repair or replace if they are defectively.
Transmission gear jumping	Gear shift fork gear shift drum stopper spring	Repair	① If the gear shift fork finger is deformed or excessively worn, it should be replaced. ② Replace if the spring compressive force is inadequate.

Troubles	Probable Cause	Remedy	Procedure
Noise			
Tappet noise	• Tappet clearance	Adjust	Adjust the proper clearance if it is too large.
	• Wear of rocker arm and shaft	Replace	Replace the rocker arm and shaft if excessively worn.
Piston slap	• Large clearance between piston and cylinder	Replace	Piston or cylinder should be replaced, use its oversize of piston and piston ring.
	• Large clearance of bearing ends of connecting rod	Repair	Replace the worn parts when the connecting rod to piston pin or to crank pin clearance are excessively large.
Cam chain noise	• Cam chain tensioner, chain and wear of sprocket teeth	Adjust or replace	<ul style="list-style-type: none"> • Perform the adjustment or replacement if the cam chain tensioner is inoperative. • The stretched chain should be replaced. • Excessive worn teeth of sprocket (cam side, timing side) should be replaced.
Clutch chattering noise	Clutch outer and friction disk	Replace	• Replace the worn parts if there are excessive looseness between them.
Crankshaft noise	Bent center of crankshaft and crank pin, worn bearing	Align and replace	Align the crankshaft if there are excessive deflection at the center of crank shaft. Bent crank pin and worn bearing should also be replaced.
Primarily drive gear's noise	Drive or driven gear	Inspect and replace	Carefully check to the teeth face of drive or driven gear on which there are excessive wear, replace them.

FRAME

1. FRONT SUSPENSION

When assembling the front cushion, particular attention should be given to the following items.

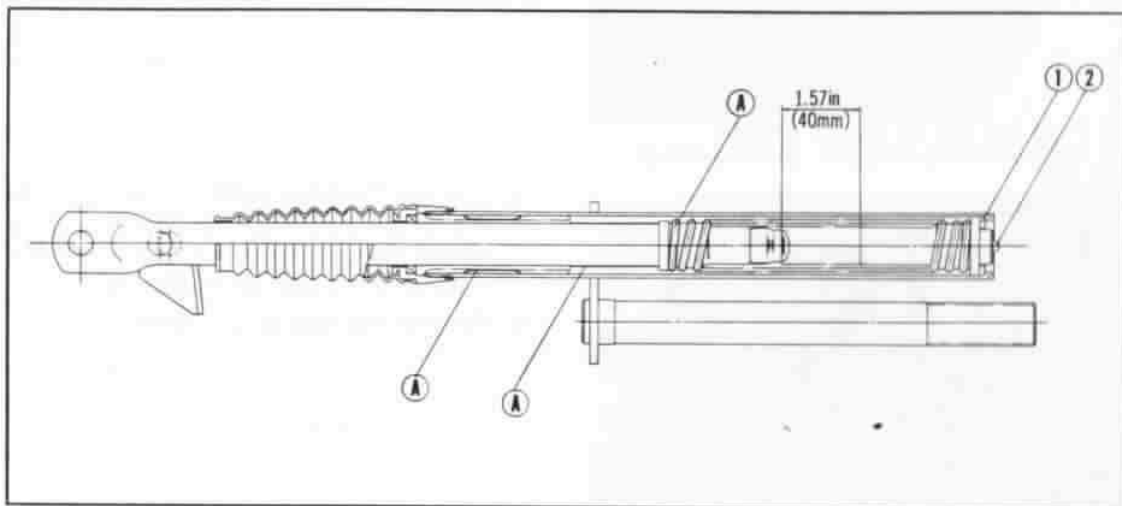

① Spring seat washer ② Dowel pin
Fig. 54

1. Apply ample amount of good quality grease to the area **A** indicated by heavy lines in Fig. 54 when installing the front fork cushion assembly to the front fork.
2. Do not forget to install the seat washer **1**.
3. Positively insert the alignment dowel pin **2** of the front fork cushion into the steering handle holder before tightening the bolts.

2. REAR BRAKE (U.S.A. Type)

A. Description

The rear brake is operated by the right foot pedal or the left hand lever.

B. Disassembly

1. Remove the brake rod adjusting nut and separate the brake rod **B** from the brake lever (Fig. 55).

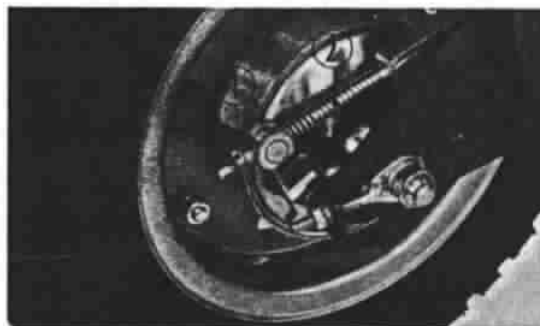

① Brake rod adjusting nut ② Brake rod **B**
Fig. 55

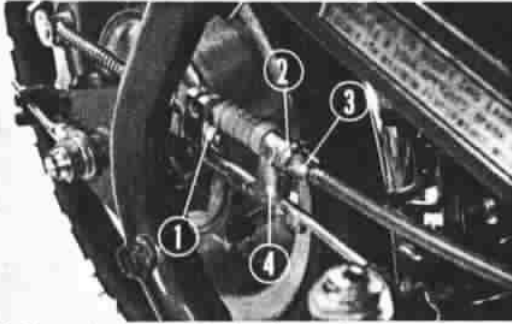

① 6 mm lock nut ② Circular lock nut
③ Brake cable adjusting bolt ④ Brake rod ⑤
Fig. 56

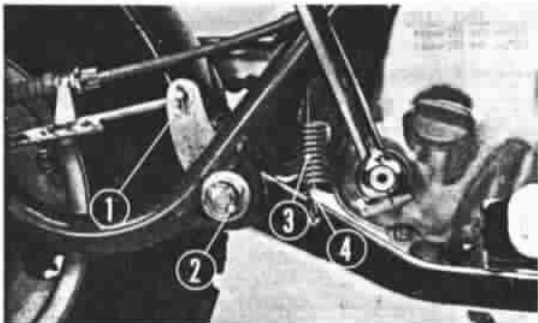

① Pin ② Brake pedal pin nut
③ Brake pedal spring ④ Stop lamp switch spring
Fig. 57

2. Loosen the circular lock nut and remove the brake cable from the brake rod ⑤ (Fig. 56).
3. Remove 6 mm lock nut and a pin. Then remove the brake rod ⑤ and ⑥ (Fig. 56, 57).

4. Remove the brake pedal pin nut, unhook the brake pedal spring and stop lamp switch spring from the brake pedal and remove the brake pedal (Fig. 57).
5. Perform the rear wheel removal.

C. Inspection

1. Check the brake rods for bent and damage. Straighten the bent rod and replace the rod if damaged.
2. Check the spring and brake pedal for deformation or damage. If damaged, replace them with new one.
3. Check the brake cable for break. Replace the broken cable with new one.

D. Reassembly

Perform the reassembly in the reverse order of disassembly.

E. Adjustment

1. Make the adjustment of left hand lever play independently by turning the brake cable adjusting bolt. Turn clockwise to increase the play. The nominal free play is 0.8-1.2 (20-30 mm).

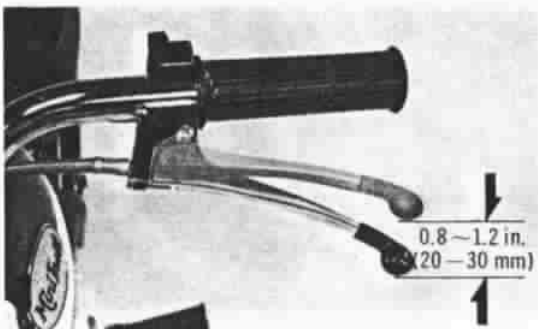
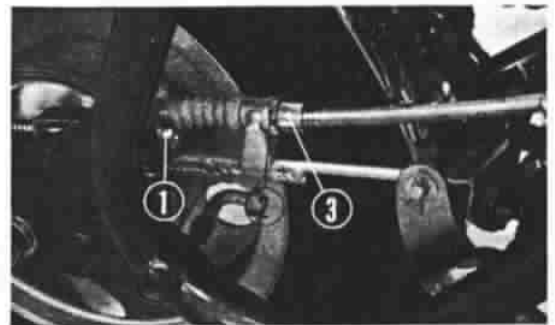

Fig. 58

2. Make the adjustment of pedal tip travel with the brake rod adjusting nut. Turn clockwise for less free travel, counter-clockwise for greater free travel. The nominal free play is 0.4-0.8 (10-20 mm).



① Brake rod adjusting nut ② Circular lock nut
③ Brake cable adjusting nut
Fig. 59

3. The light should come on when the brake pedal is depressed 0.4 (10 mm). Turning the adjuster nut clockwise will delay the switch engagement (Fig. 60).

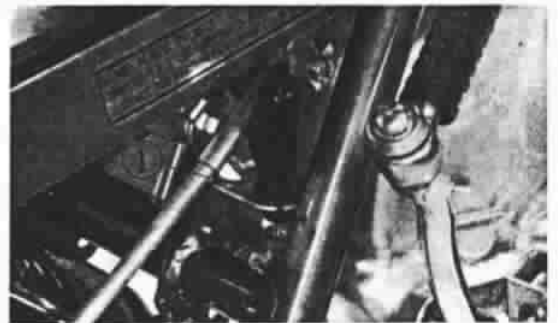

Fig. 60 ① Adjuster nut



FRAME (K3, K4, K5)

1. FRONT SUSPENSION

On the models Z50AK3, Z50AK4 and Z50AK5, the overall length and stroke were changed.

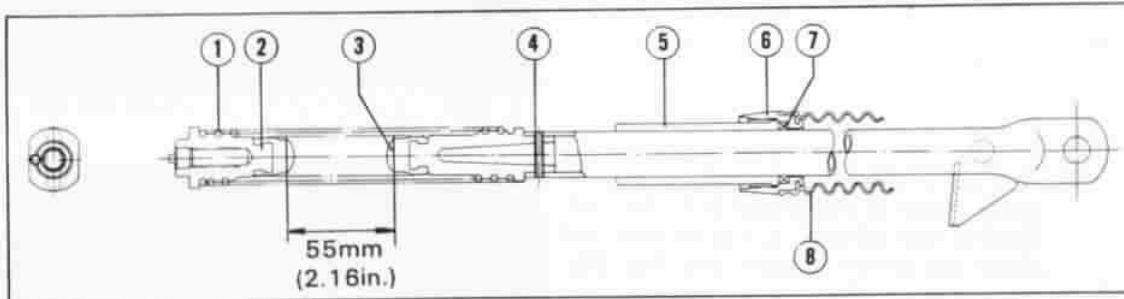

- | | |
|--------------------------------|-----------------------|
| ① Front cushion spring | ⑤ Fork pipe guide |
| ② Spring upper holder | ⑥ Fork pipe guide cap |
| ③ Front cushion stopper rubber | ⑦ Oil seal |
| ④ Spring pin | ⑧ Front fork boot |

Fig. 1

2. FUNCTION OF REAR SUSPENSION

On the model Z50AK3, the rear suspension was newly employed in connection with the change in shape of the fram. This rear suspension uses single tube, friction type dampers. Each cylinder is filled with some amount of grease for lubrication

• Operation

The head of the damper rod acts as a piston and it slides along the internal wall of the cylinder to cause the friction to be produced.

- Since friction is produced in both directions (when the shock absorber contracts and extends), this rear damper is of a double-acting type.
- The rebound stop spring is provided to absorb a shock load when the shock absorber is fully extended.

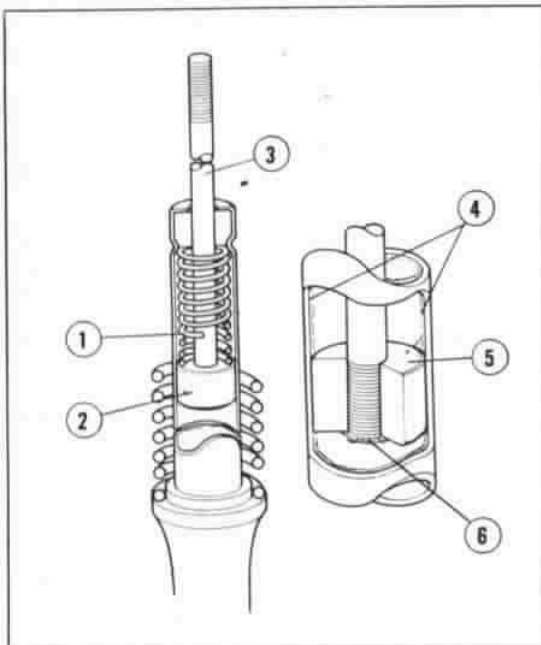

- ① Rear cushion rebound spring
 ② Rear cushion rod guide ③ Rod ④ Grease
 ⑤ Piston ⑥ Rebound stopper spring seat

Fig. 2

3. CAM CHAIN ADJUSTMENT

Too tight or too loose a cam chain will adversely affect the engine. Adjust the chain tension while the engine is idling.

1. To adjust, loosen the lock nut ① and back off the tensioner adjusting bolt ② approximately 1/2 turn.
2. If the chain is still noisy after adjusting, loosen the 14 mm sealing bolt located at the left lower side of the crankcase and tighten the tensioner bolt ③ gradually until the chain becomes quiet. Upon completing the adjustment, tighten the tensioner adjusting bolt, lock nut and 14 mm sealing bolt securely.

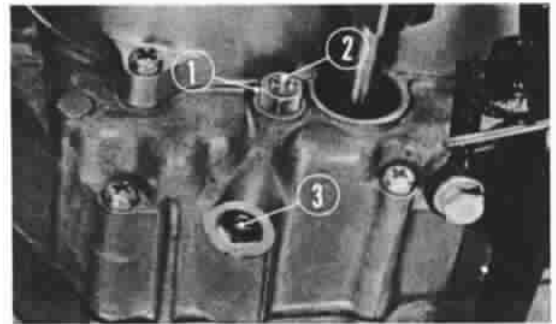

① Tensioner adjusting bolt lock nut
② Tensioner adjusting bolt
③ Tensioner bolt

Fig. 3

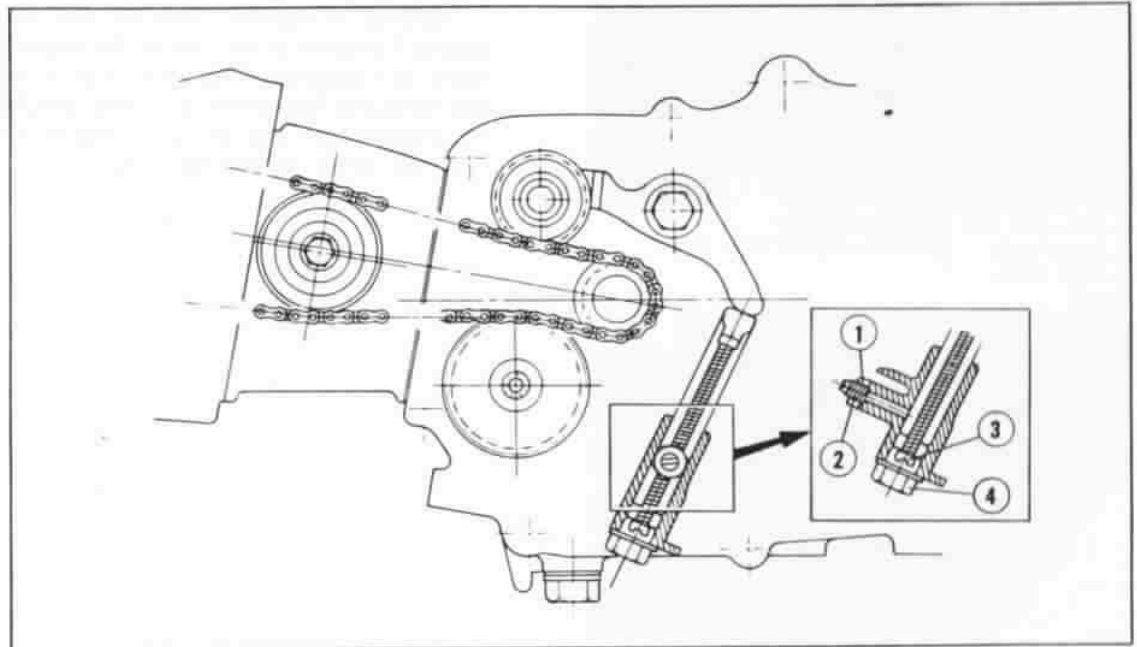

① Tensioner adjusting bolt lock nut
② Tensioner adjusting bolt

③ Tensioner bolt
④ 14 mm sealing bolt

Fig. 4

4. DRIVE CHAIN MAINTENANCE

Adjustment of the drive chain tension will have a considerable effect on the transmission of power from the engine to the rear wheel and on the service life of the chain. Therefore, the chain tension should always be adjusted correctly. Every time the chain tension is adjusted, the chain must be lubricated.

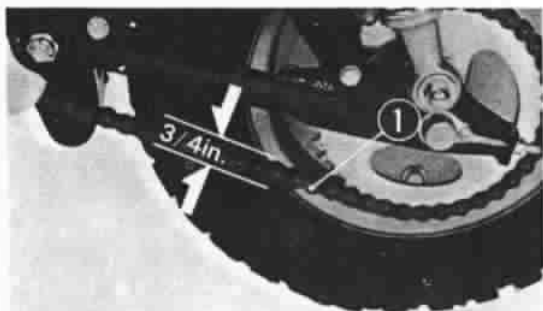

① Drive chain
Fig. 5

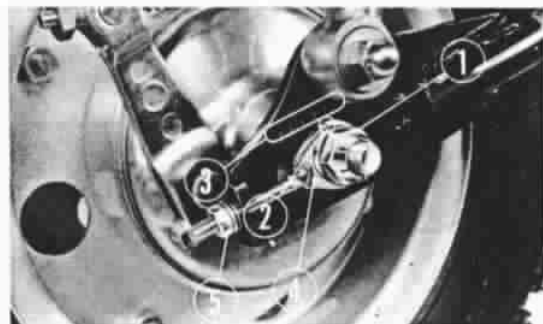

① Rear axle nut ④ Chain adjuster
② Index mark ⑤ Chain adjuster lock nut
③ Side scale
Fig. 6

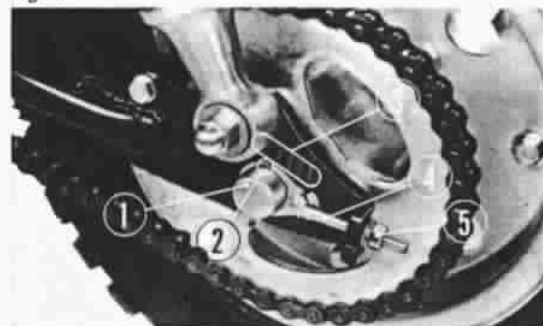

① Rear axle shaft ④ Chain adjuster
② Index mark ⑤ Chain adjuster lock nut
③ Side scale
Fig. 7

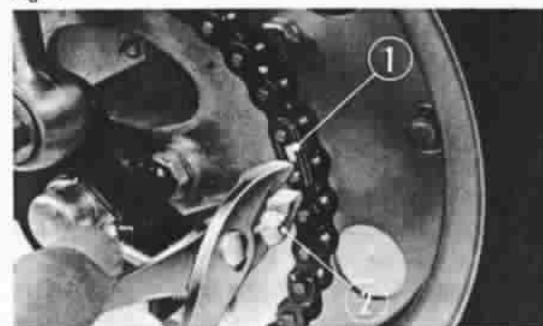

① Retaining clip ② Pliers
Fig. 8

1. Push the chain up and down at the mid-point between the sprockets to check the chain tension. The maximum slack of the chain should be 3/4 inch.

2. To adjust, loosen the rear axle nut.
3. Then turn the chain adjuster lock nut in either direction. Turning the lock nut clockwise will decrease the chain slack or turning it counterclockwise will increase the chain slack. When the adjustment is completed, the index marks on the right and left chain adjusters should be aligned with the reference marks on the both sides of the rear fork.

4. Finally, tighten the axle nut securely.
5. If the drive chain is excessively dirty, clean it in the following manner.
 - a. Carefully remove the master link retaining clip ① with pliers. Do not bend or twist the clip. Remove the master link. Remove the drive chain from the Mini-Trail.

- b. Clean the chain in solvent and dry it (Fig. 9).

Check the chain for wear or damage. Replace any chain that has damaged rollers, loose fitting links or otherwise appears unserviceable.

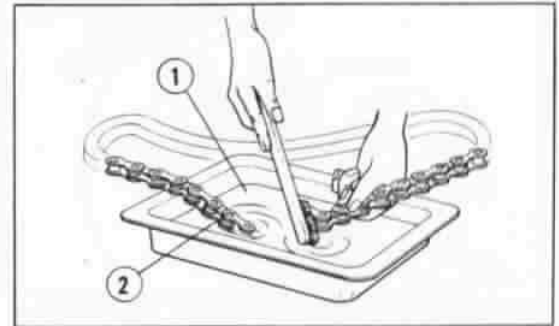

① Solvent ② Chain

Fig. 9

- c. Check the sprocket teeth for wear or damage and replace if necessary (Fig. 10).

Never use a new drive chain with badly worn sprocket. Both the chain and sprockets must be in good condition.

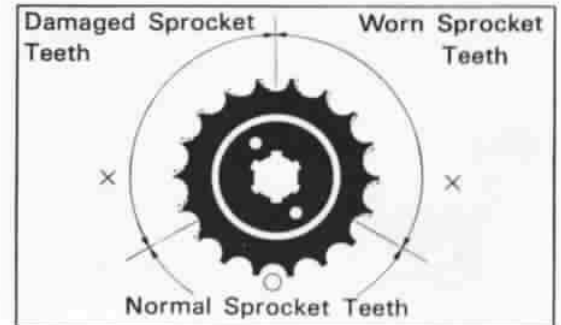

① Drive sprocket

Fig. 10

- d. Lubricate the chain. Commercially available drive chain lubricants may be purchased at most motorcycle shops and should be used in preference to motor oil or other lubricants.

Saturate each chain link joint, so that the lubricant will penetrate the space between the adjacent surfaces of the link plates and rollers.

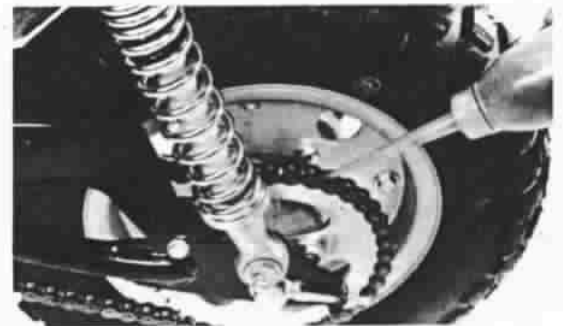

Drive chain lubricants

Fig. 11

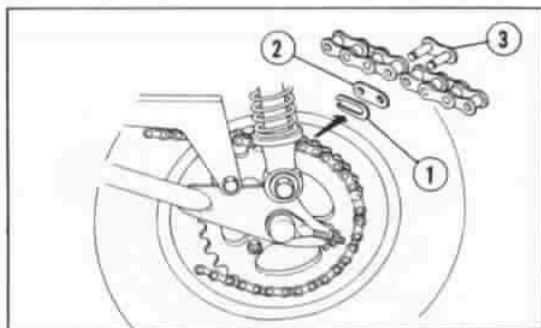

① Retaining clip ② Retaining plate ③ Master link
Fig. 12

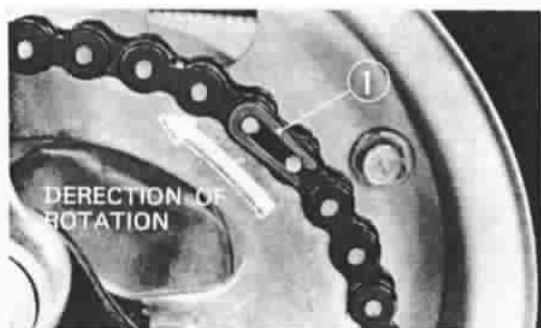

① Retaining clip
Fig. 13

- e. Install the chain on the sprockets and join the ends with the master link. For ease of assembly, hold the chain ends against the adjacent rear sprocket teeth while inserting the master link. Install the master link retaining clip so that the closed end will face in the direction of forward wheel rotation.

The master link is the most critical part affecting the security of the drive chain. Master links are reusable, if they remain in excellent condition, but it is recommended that a new master link be installed whenever the drive chain is reassembled.

- f. Adjust the chain tension. (See page 36).

Note :

If the drive chain is excessively loose when the rear axle is moved to the rearward limit of adjustment, it is worn out and must be replaced.

5. FRONT WHEEL AND FRONT BRAKE

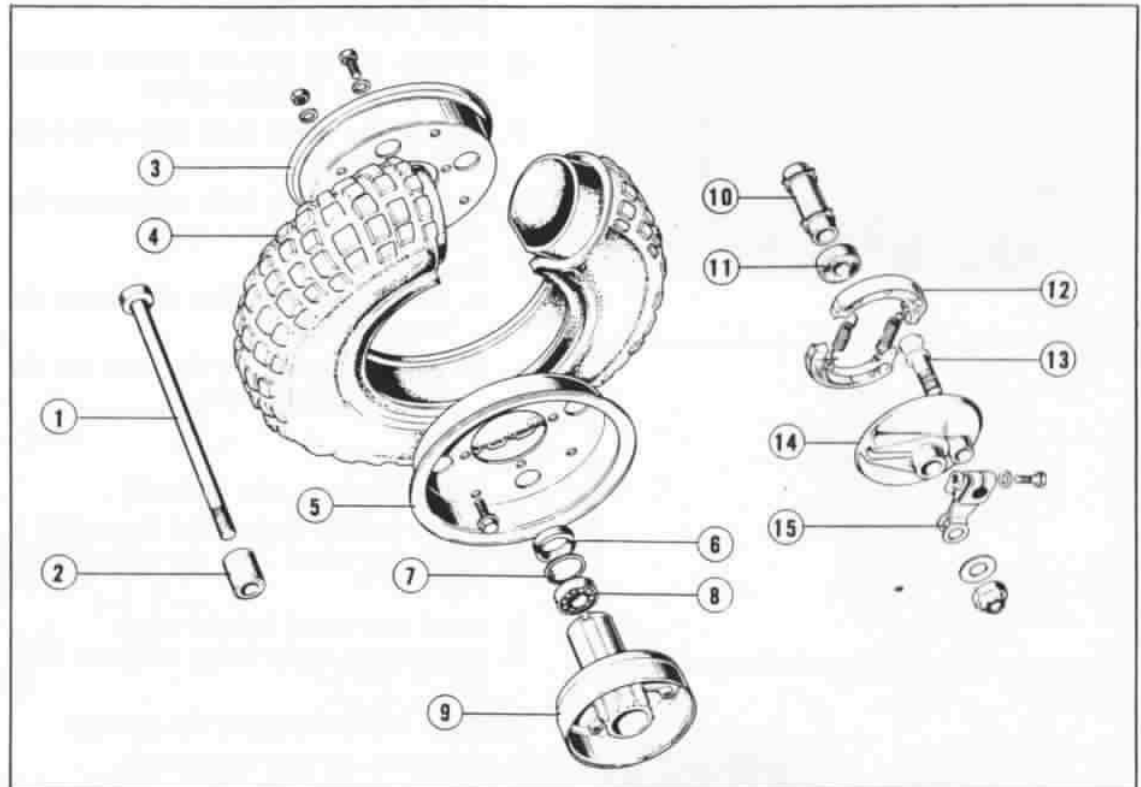

- | | |
|----------------------------|------------------------------|
| ① Front wheel axle | ⑨ Front wheel hub |
| ② Front wheel side collar | ⑩ Front axle distance collar |
| ③ Left wheel rim | ⑪ Radial 6201R ball bearing |
| ④ Wheel tire | ⑫ Brake shoe |
| ⑤ Right wheel rim | ⑬ Rear brake cam |
| ⑥ Oil-seal, 21×35×55 | ⑭ Rear brake panel |
| ⑦ Internal 32 mm cir-clip | ⑮ Front brake arm |
| ⑧ Radial 6201 ball bearing | |

Fig. 14

A. Disassembly

1. Place a proper wood block under the engine to raise the front wheel off the ground.
2. Remove the front brake adjusting nut ① and disconnect the front brake cable from the brake arm.
3. Remove the front axle nut ② and pull out the front axle ③ (Fig. 15).
4. Remove the front wheel.

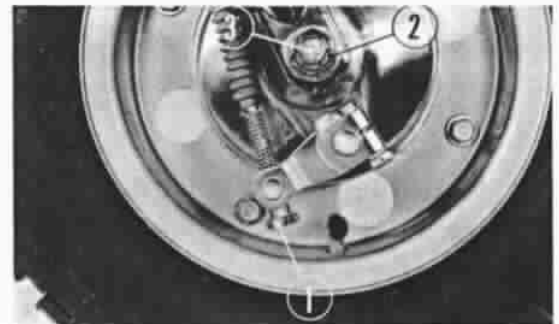

- | |
|-----------------------------|
| ① Front brake adjusting nut |
| ② Front axle nut |
| ③ Front axle |

Fig. 15

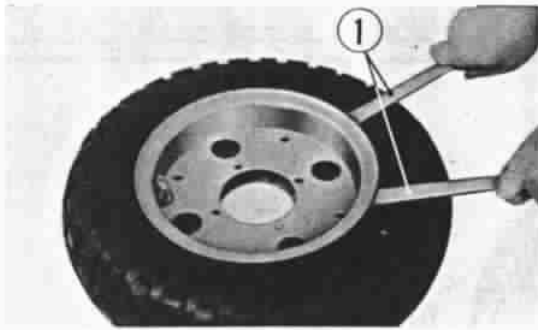

① Tire wrench
Fig. 16

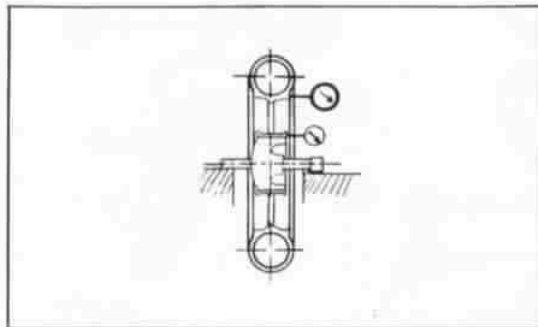

① Dial guige
Fig. 17

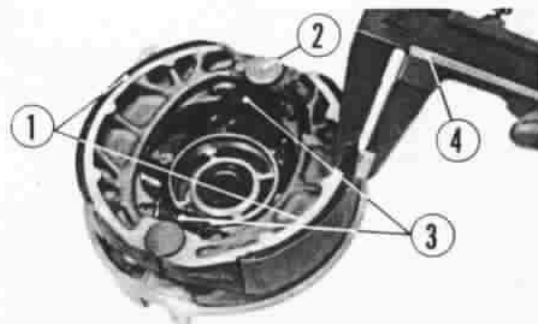

① Brake shoe ② Brake shoe cam
③ Brake shoe spring ④ Vernier caliper
Fig. 18

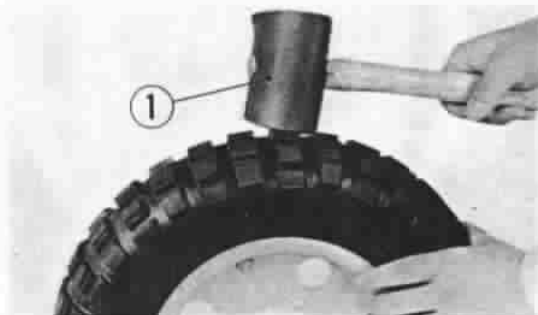

① Rubber hammer
Fig. 19

5. Remove the brake arm, cam and shoe springs in this order and remove the brake shoes from the panel.
6. Remove the oil seal and pull out the ball bearings and distance collar.
7. Remove the 8 mm bolts and remove the front wheel hub.
8. Remove the 6 mm bolts and remove the wheel rims and tire.

Notes :

1. Before removing the tire, open the valve to deflate.
2. When removing the tire, use the tire wrench (special tool).

B. Inspection

1. Check the front axle for bend.
2. Check the ball bearing for looseness.
3. Check the wheel rims for runout (Fig. 17).
4. Check the wheel hub for wear.
5. Measure the brake lining thickness (Fig. 18).
6. Check the brake panel for damage.
7. Check the oil seal for damage.
8. Check to see if metal pieces or stones are bitten in the tire tread pattern or wall.
9. Check for air leakage from the tire valve.

C. Assembly

1. Slightly inflate the tire and install the wheel rims.

Note :

Upon noting that the rims are properly installed to the tire, tighten the 8 mm hex. bolts. Inflate the tire to 1/3 the specified pressure and give a light tap to the circumference of the tire using a mallet to prevent the tube from being bound. Inflate the tire to the specified pressure (Fig. 19).

Tire inflation pressure

	Unit: kg/cm ² (psi)
	250
Front wheel	1.0 (14.2)
Rear wheel	1.0 (14.2)

- Fill the cavity in the ball bearing and inside the wheel hub with grease. Put the distance collar in position and drive the bearing in.
 - Install the wheel hub to the rims using the 8 mm bolts.
 - Install the brake cam to the brake panel. Attach the brake shoe springs to the brake shoes and secure to the brake panel (Fig. 20).
 - Install the brake arm.
 - Install the brake panel in the front wheel.
 - Fit the lug of the front shock absorber into the groove in the brake panel (Fig. 21).
- Insert the front axle, tighten the axle nut and secure with the cutter pin.
- Connect the front brake cable to the brake arm and adjust the front brake (Fig. 22).

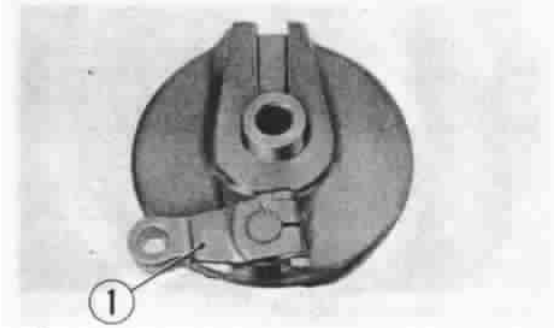

① Brake arm
Fig. 20

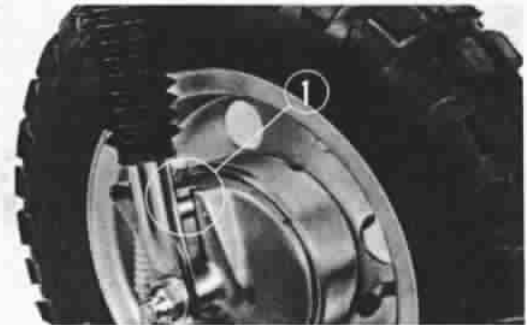

① Groove in brake panel
Fig. 21

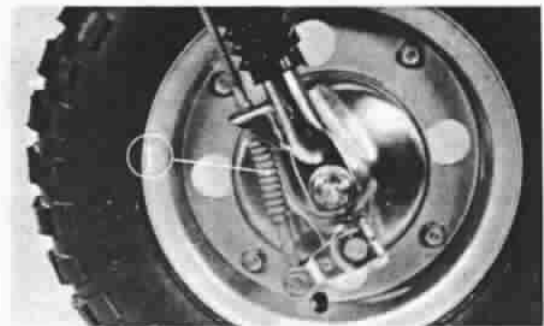

① Front brake cable
Fig. 22

D. Front brake adjustment

Brake are items of personal safety and should always be adjusted correctly.

The front brake lever free play should be 0.4 to 0.8 inch (10 to 20 mm) as measured at the tip of the lever ① (Fig. 23). Free play is the distance the brake lever moves before the brake starts to engage.

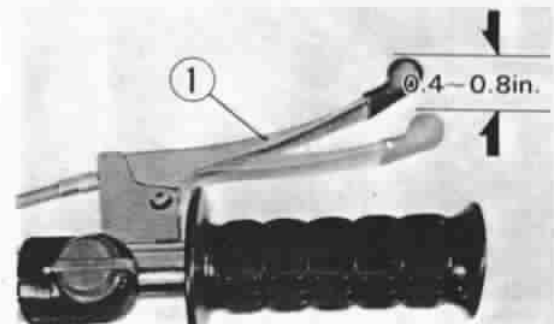

① Front brake lever
Fig. 23

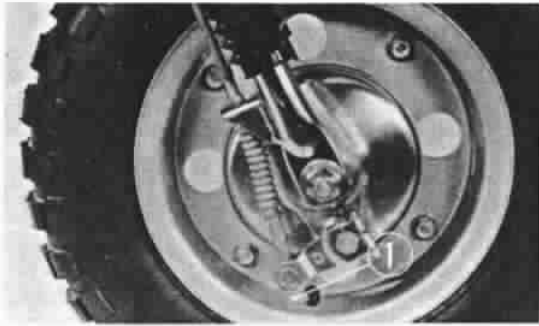

① Front brake adjusting nut
Fig. 24

1. To adjust, turn the front brake adjusting nut ① in either direction (Fig. 24). Turning the adjusting nut clockwise will decrease the free play and turning it counterclockwise will increase the free play.

6. REAR WHEEL AND REAR BRAKE

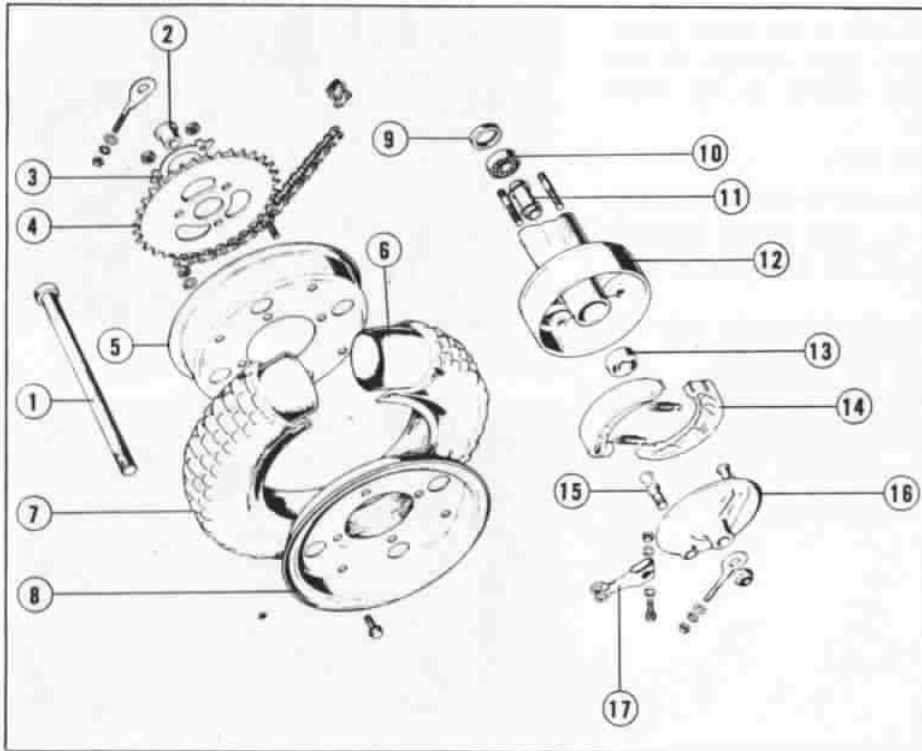

- ① Rear wheel axle
 - ② Left rear wheel side collar
 - ③ Tongued washer B
 - ④ Final driven sprocket
 - ⑤ Left wheel rim
 - ⑥ Wheel tube
 - ⑦ Wheel tire
 - ⑧ Right wheel rim
 - ⑨ Oil seal, 18328
 - ⑩ 6201 radial ball bearing
 - ⑪ Rear axle distance collar
 - ⑫ Rear wheel hub
 - ⑬ 6201R radial ball bearing
 - ⑭ Brake shoe
 - ⑮ Rear brake cam
 - ⑯ Rear brake panel
 - ⑰ Rear brake arm
- Fig. 25

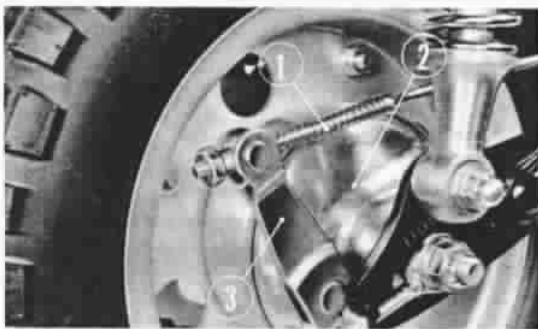

① Brake rod ② Brake panel ③ Brake arm
Fig. 26

A. Disassembly

1. Loosen the axle nut and adjuster nut.
2. Disconnect the rear brake rod (Fig. 26).

3. Remove the drive chain joint
4. Remove the axle nut and pull out the axle shaft (Fig. 27). Take out the wheel.
5. Remove the brake panel from the wheel hub.
6. Remove the brake cam, cam spring and brake shoes.

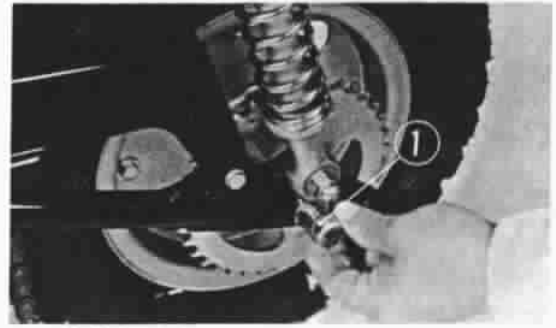

① Axle shaft
Fig. 27

7. Remove the three 8 mm nuts and remove the final driven sprocket (Fig. 28).
8. Pull out the oil seal, bearing and distance collar.
9. Remove the 6 mm bolts and 8 mm bolts and remove the wheel rims, wheel hub and tire.

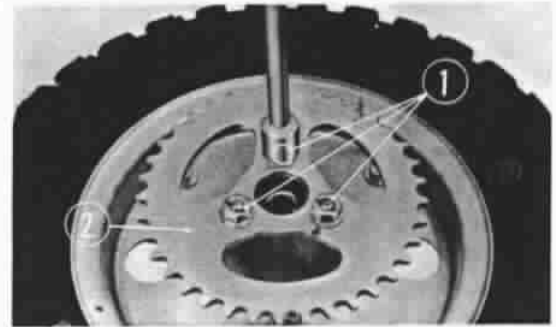

① 8 mm nuts ② Final driven sprocket
Fig. 28

B. Inspection

1. Check the rear axle for bend.
2. Check the wheel bearing for looseness.
3. Check the wheel rims for runout.
4. Check the wheel hub for wear (Fig. 29).

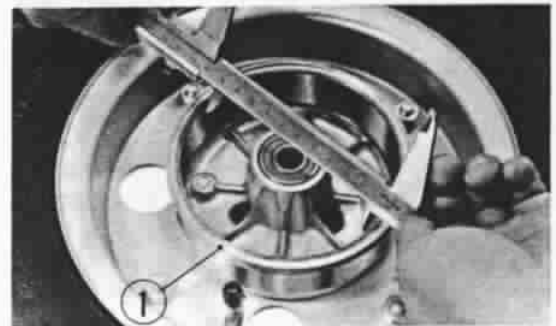

① Wheel hub
Fig. 29

5. Measure the brake lining thickness (Fig. 30).
6. Check the brake panel for damage.
7. Check the oil seal for damage.
8. Check to see if metal pieces or stones are bitten in the tire tread pattern or wall.
9. Check for air leakage from the tire valve.

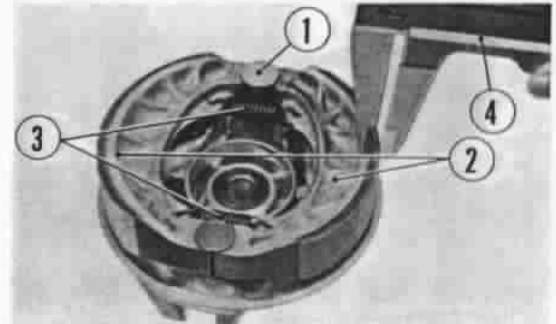

① Brake shoe cam ② Brake shoe
③ Brake shoe spring ④ Vernier caliper
Fig. 30

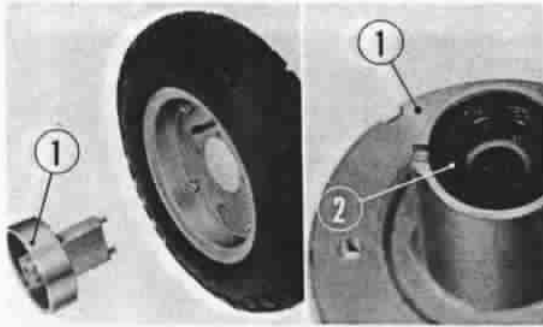

① Wheel hub ② Grease
Fig. 31

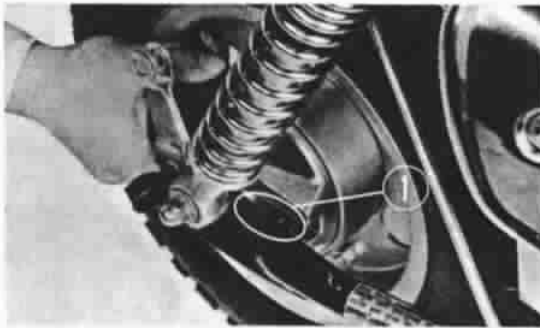

① Groove in brake panel
Fig. 32

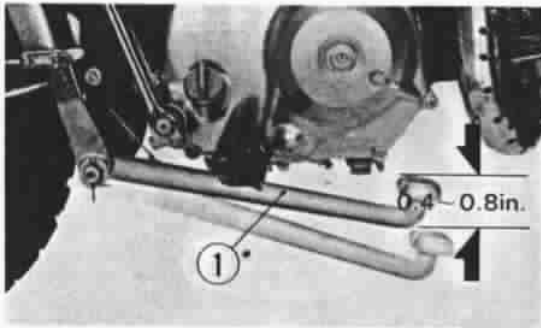

① Rear brake pedal
Fig. 33

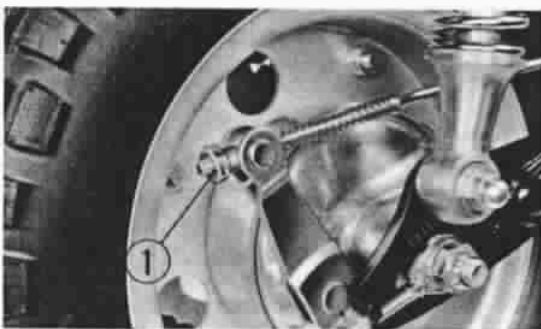

① Rear brake adjust nut
Fig. 34

C. Assembly

1. To assemble, reverse the disassembly procedures.
2. Install the tire to the wheel rims in the same manner as in the front wheel.
3. Fill the cavity in the ball bearing and inside the wheel hub with grease. Put the distance collar in position and drive the ball bearing in.
4. Install the wheel hub to the rims (Fig. 31).
5. Fit the lug of the rear fork into the groove in the rear brake panel. (Fig. 32)
6. Insert the rear axle tighten the axle nut.

D. Rear brake adjustment

The rear brake pedal free play should be 0.4 to 0.8 inch (10 to 20 mm) as measured at the tip of the pedal ① (Fig. 33).

Free play is the distance the brake pedal moves before the brake starts to engage.

1. To adjust, turn the rear brake adjusting nut ① in either direction (Fig. 34). Turning the adjusting nut clockwise will decrease the free play and turning it counterclockwise will increase the free play.

7. STEERING SYSTEM

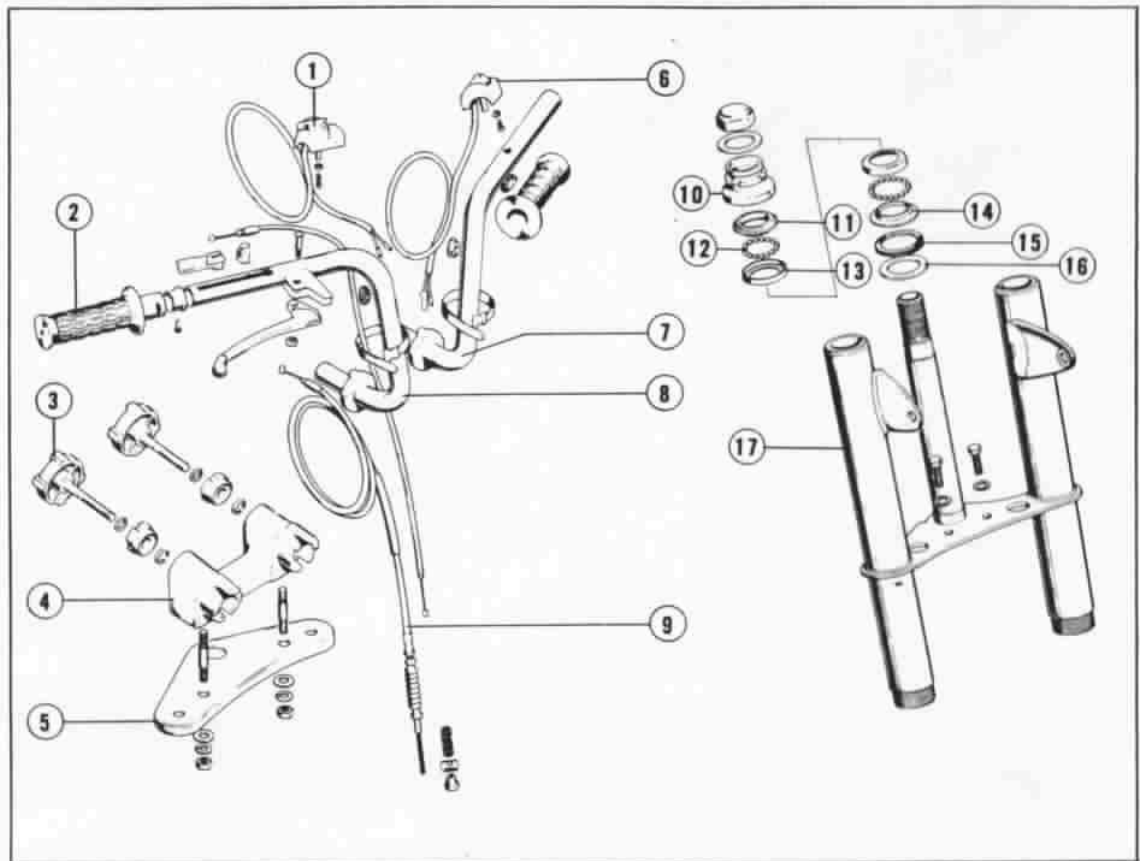

- | | |
|------------------------------|----------------------------------|
| ① Throttle cable | ⑩ Steering head top thread |
| ② Right handle grip A | ⑪ Steering top cone race |
| ③ Handle holder knob | ⑫ 6 steel ball |
| ④ Steering handle holder | ⑬ Steering top ball race |
| ⑤ Fork top bridge | ⑭ Steering bottom cone race |
| ⑥ Lighting switch | ⑮ Steering head dust-seal |
| ⑦ Left steering handle pipe | ⑯ Steering head dust-seal washer |
| ⑧ Right steering handle pipe | ⑰ Front fork |
| ⑨ Front brake cable | |

Fig. 35

A. Disassembly

1. Disconnect the brake cable from the right handlebar.
2. Disconnect the throttle cable from the throttle grip pipe.
3. Remove the headlight and disconnect the wires inside the headlight case.
4. Turn the handlebar holder knobs and remove the handlebar pipes.
5. Remove the front wheel. (See Section 5-A.)
6. Remove the headlight case, front fender, horn handle lock and turn signals.

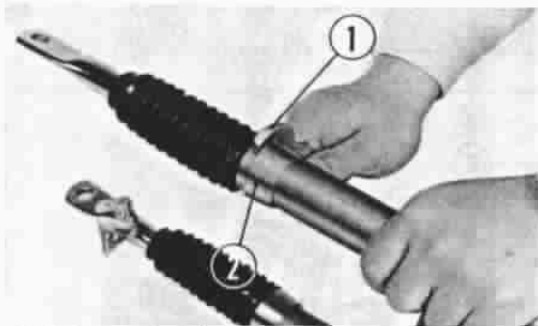

① Fork top thread
 ② Front fork guide cap
 Fig. 36

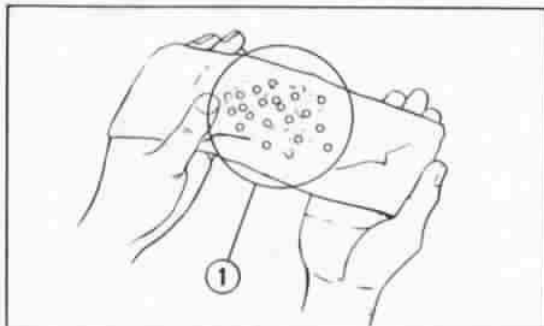

① Steel ball
 Fig. 37

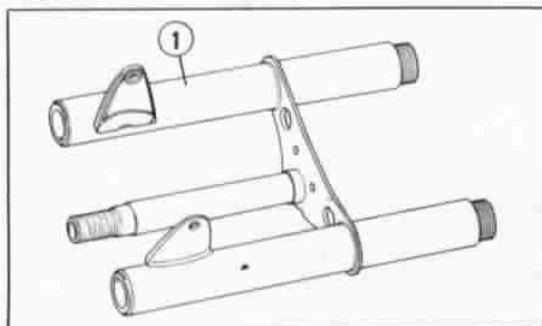

① Steering stem
 Fig. 38

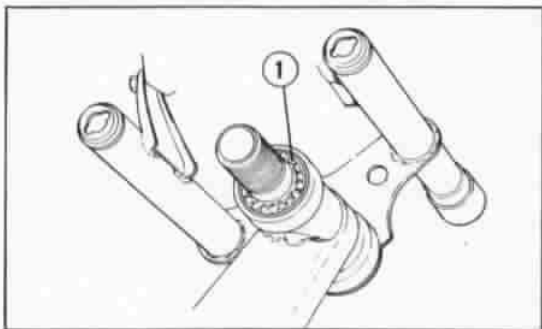

① Grease
 Fig. 39

7. Remove the front fork bolts and loosen the fork guide caps (Fig. 36). Then pull out the front shock absorber assemblies.
8. Remove the steering handle holder and remove the steering stem and front.
9. Remove the steering head top thread and steering top cone race. Then remove the steering top ball races, bottom cone race and steel balls.

Caution :

Take care not to drop the steel balls.

B. Inspection

1. Check the control cables for proper operation. Also check for breakage or any other damage. Relubricate if necessary.
2. Check the steel balls for wear or damage (Fig. 37).
3. Check the contact surfaces of the steering top and bottom cone races and steering top ball races for scores, scratches or wear.
4. Check the steering stem for bend or twist (Fig. 38).
5. Check the threaded parts for breakage or deformation.
6. Check the handlebar holder for breakage.

C. Assembly

1. To assemble, reverse the disassembly procedures.
2. Before installing the cone races, ball races and steel balls, wash them clean and apply a coat of new grease to them (Fig. 39).
3. Adjust the control cables.

8. FRONT SHOCK ABSORBERS

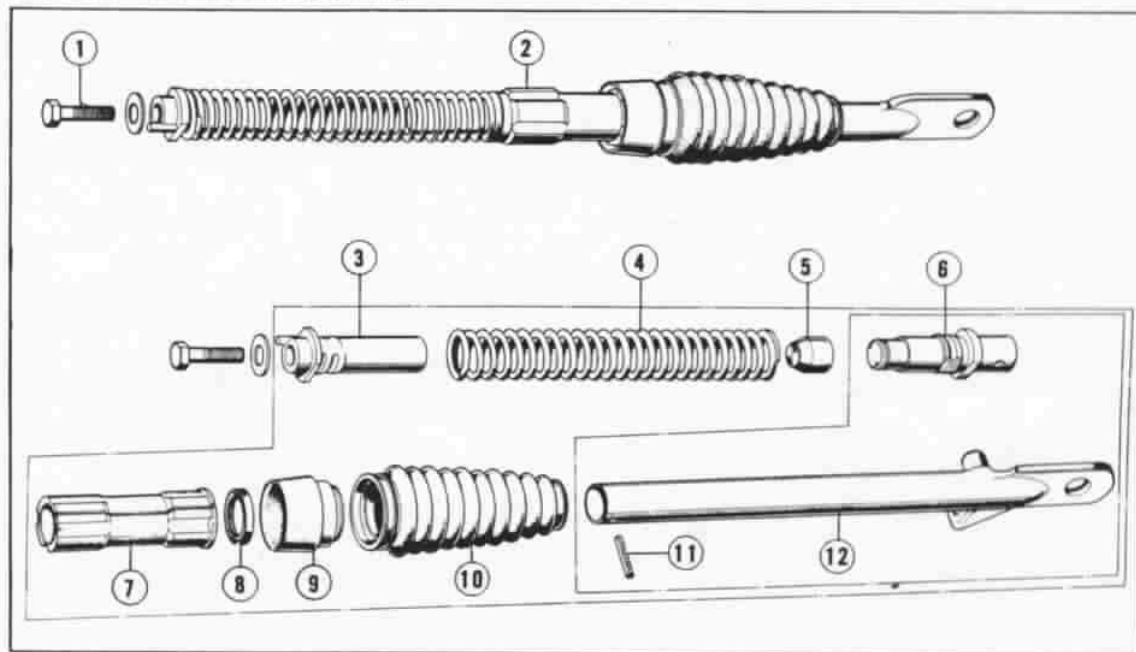

- ① Front fork bolt ④ Front cushion spring ⑦ Front fork pipe guide ⑩ Front fork boot
 ② Front cushion assy. ⑤ Front cushion stopper rubber ⑧ Oil-seal ⑪ Spring pin
 ③ Spring upper holder ⑥ Spring lower holder ⑨ Fork pipe guide cap ⑫ Front cushion half pipe

A. Disassembly

Fig. 40

1. Remove the front shock absorber assemblies. (See Section 7-A.)
2. Pull out the spring pin and disassemble each shock absorber.

B. Inspection

1. Measure the shock absorber spring free length.
2. Check the spring stops for scores, scratches or breakage.

C. Assembly

To assemble, reverse the disassembly procedures. Tighten the bolts, nuts, etc. to the specified torque. (See page 56.)

Note :

The spring pin must be flush with the end faces of the piston.

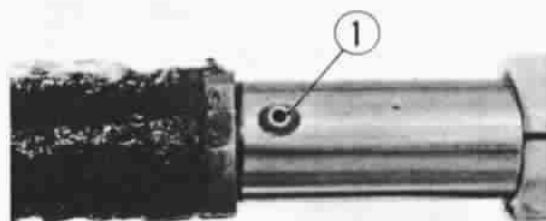

① Stopper pin
Fig. 41



① Fork top thread
Fig. 42

9. REAR SUSPENSION

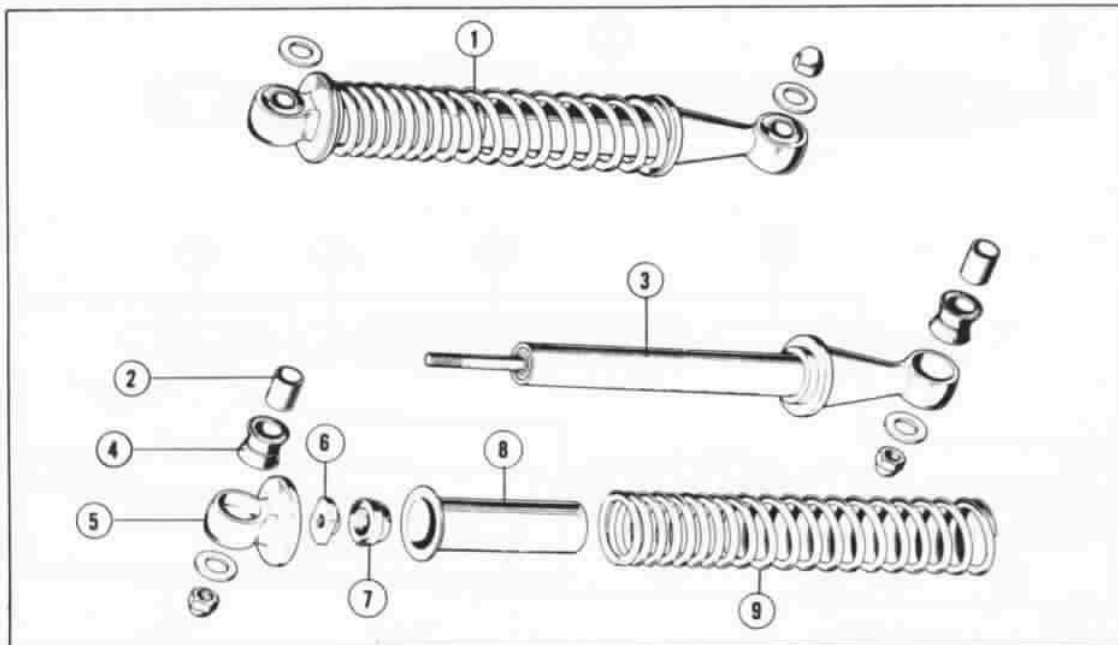

- ① Rear shock absorber assy ④ Rear cushion rubber brush ⑦ Rear cushion stopper rubber
 ② Rear cushion rubber collar ⑤ Rear cushion upper metal ⑧ Rear cushion spring guide
 ③ Rear damper ⑥ Rear cushion upper lock nut ⑨ Rear cushion spring

Fig. 43

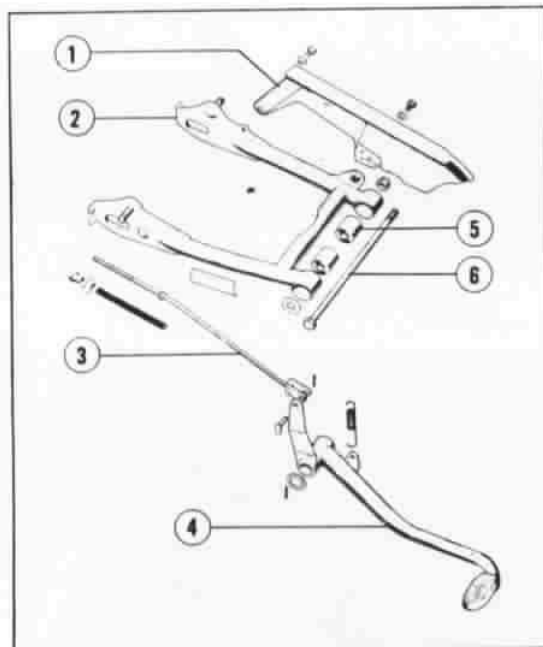

- ① Drive chain case ② Rear fork
 ③ Rear brake rod ④ Rear brake pedal
 ⑤ Rear fork pivot rubber bush
 ⑥ Rear fork pivot bolt

Fig. 44

A. Disassembly

1. Remove the rear wheel. (See Section 6-A.)
2. Remove the chain cover.
3. Remove the rear shock absorber attaching cap nuts and remove the rear shock absorber assemblies from the frame and rear fork.
4. Remove the brake pedal and brake rod.
5. Remove the pivot bolt and nut and remove the rear fork.

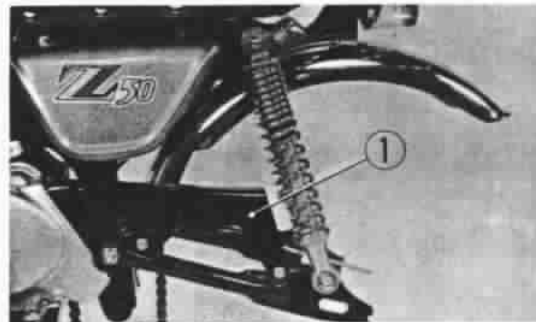

① Chain case cover
 Fig. 45

5. Using a special tool, loosen the locking nut, remove the upper metal and disassemble each rear shock absorber. (See Fig. 46.)

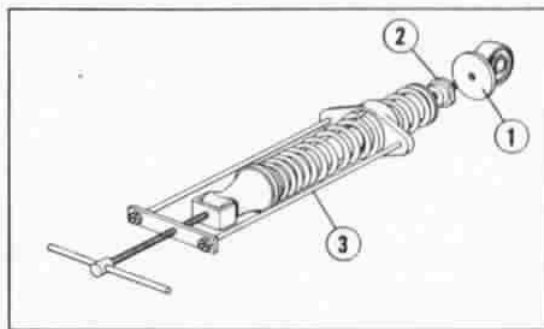

① Rear shock absorber upper metal
 ② Locking nut
 ③ Rear shock absorber dis/assembly tool
 Fig. 46

B. Assembly

1. To assemble, reverse the disassembly procedures.

Notes:

1. Install the spring with the smaller pitch end upward.
2. Apply a coat of locking sealant to the upper metal.
2. Install the rear shock absorbers to the rear fork and frame and secure with the cap nuts. (See Fig. 47.) See the Tightening Torque Standard.
3. Install the rear wheel. (See Section 6-C.)

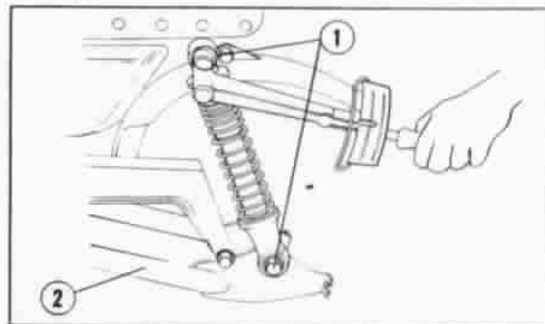

① Cap nut ② Rear fork
 Fig. 47

10. FRAME BODY, SEAT, FUEL TANK AND AIR CLEANER

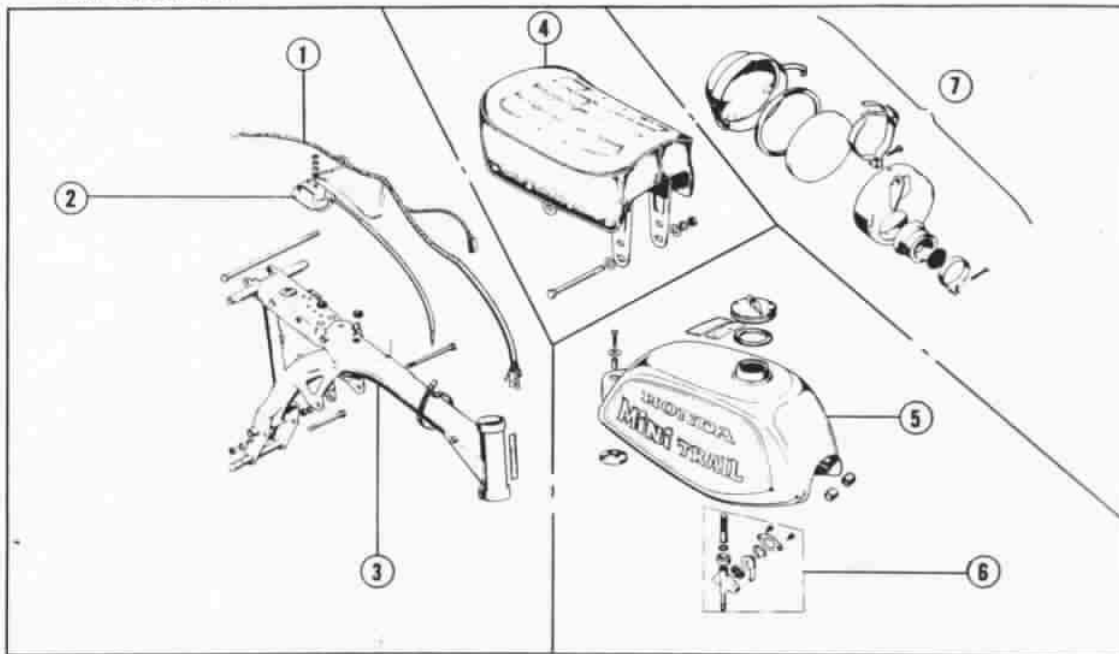
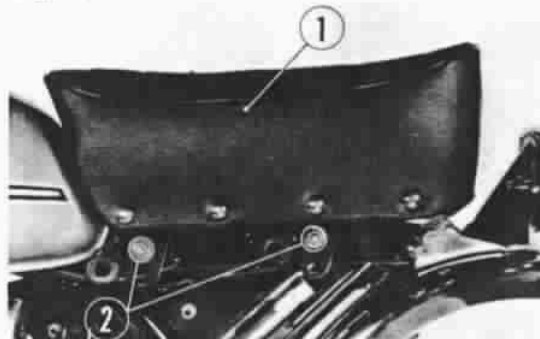

Fig. 48 ① Wire harness ③ Frame body ⑤ Fuel tank ⑦ Air cleaner assy.
 ② A.C. ignition coil assy. ④ Seat ⑥ Fuel cock assy.



① Setting 6 mm bolt
 Fig. 49



① Seat ② 8 mm bolt
 Fig. 50

A. Disassembly

1. Remove the engine. (See page 7.)
2. To remove the fuel tank, disconnect the fuel tube by pulling it and remove the 6 mm bolt.
3. To remove the seat, remove the two 8 mm bolts.
4. Remove the front wheel and front shock absorber assemblies. (See Section 5-A.)
5. Remove the rear wheel and rear suspension. (See Section 6-A.)
6. Remove the auxiliary equipment.
7. Remove the electrical parts.

B. Inspection

1. Check the welded parts for damage and the pipes for cracks, breakage or twist.
2. Check the head pipe for deformation.
3. Check for leakage from the fuel tank. Also check the vent in the fuel filler cap for clogging, the cock valve and strainer cap gaskets for deterioration or damage and the fuel tube for deterioration or breakage (Fig. 51).

Note :

Flush the tank using new gasoline.

4. Soak air filter element in clean gear oil (No. 80~No. 90) until saturated then squeeze out excess oil (Fig. 52).

Warning :

Gasoline or low flash point solvents are highly flammable and must not be used to clean air filter elements.

5. Check the painted surface of the connecting tube for peeling.
6. Check the exhaust pipe gasket for breakage and replace it if necessary (Fig. 53).

Remove carbon, if any, from the diffuser pipe using a wire brush and wash it clean.

C. Assembly

1. To assemble, reverse the disassembly procedures.
2. Route and connect the control cables and wires correctly (Fig. 54). Connect the wires, color to color, referring to the wiring diagram at the end of this manual.
3. Adjust the brakes, clutch and chain. Check the steering handlebars for proper operation.

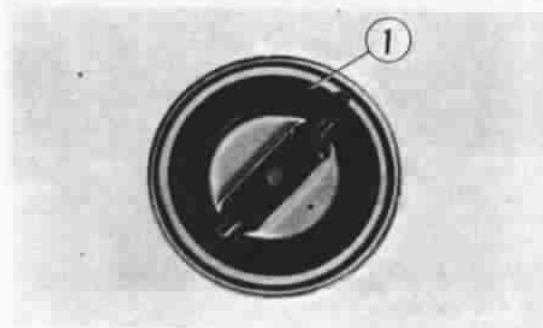

① Fuel filler cap
Fig. 51

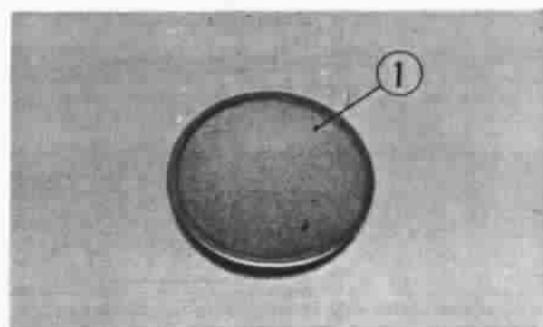

① Air filter element
Fig. 52

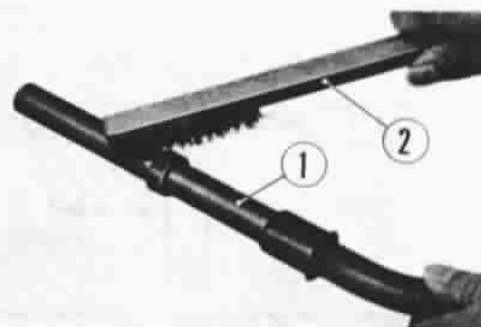

① Diffuser pipe ② Wire brush
Fig. 53

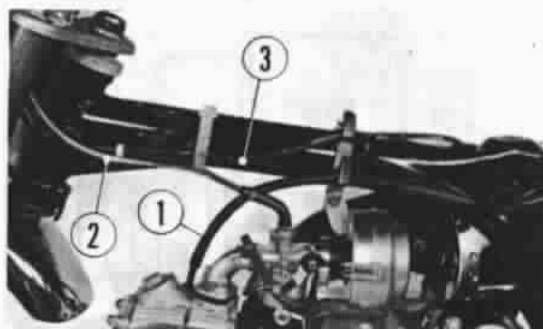

① High tension cable
② Throttle cable
③ Wire harness
Fig. 54

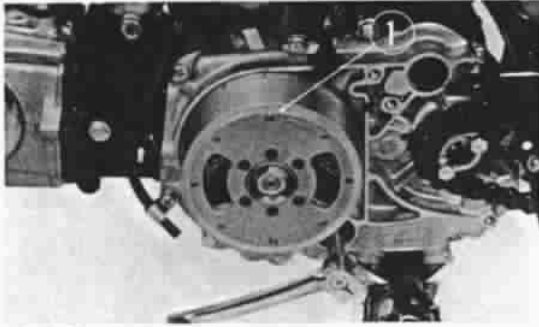

① A-C generator
Fig. 55

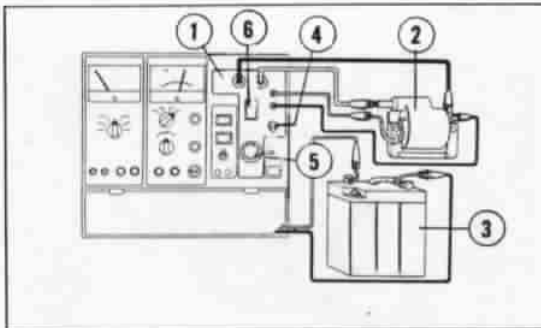

① Service tester ② Ignition coil ③ Battery
④ Coil test switch ⑤ Spark gap check dial
⑥ Spark gap finder
Fig. 56

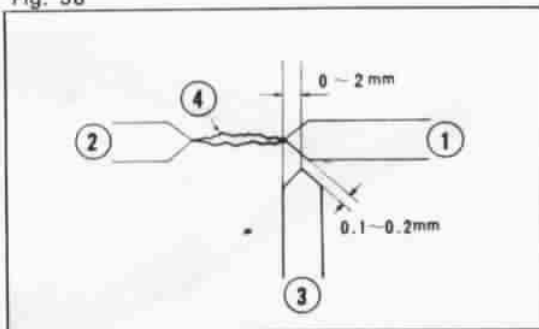

① 1st electrode ② 2nd electrode
③ 3rd electrode ④ Spark
Fig. 57

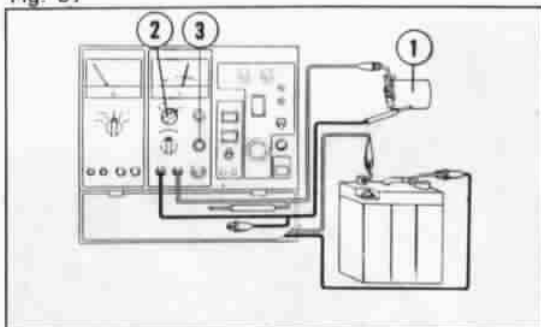

① Condenser ② Switch "II"
③ "CAPACITY" button
Fig. 58

11. ELECTRICAL SYSTEM

1. Generating System

On the model Z50A, the alternating current generated by the A-C generator consisting of a flywheel magneto and field coil is rectified by the selenium rectifier. Then the direct current is fed to the battery for charging.

A-C generator specifications

Type	Flywheel
Output	6V-15W
Battery capacity	6V-2AH
Speed under load	500~11,000 rpm
Battery polarity (ground)	Negative

2. Inspection of Electrical Parts

Inspection with a service tester (Tool No. 07308-0010000)

1. Ignition coil

Ignition coil test

This test is conducted to check the coil performance. If the engine fails to start, check the spark plug, points, condenser, etc. for condition.

- ① Use a battery and service tester and connect them as shown in (Fig. 56).
- ② Turn the service tester selector knob to COIL TEST.
- ③ Observing the spark jumping across a 3-point spark gap, turn the knob and measure the jumping distance (Fig. 57).
- ④ If the spark jumps more 6 mm (0.2362 in.) in air, the coil is in good condition.

2. Condenser

- ① Connect as shown in Fig. 58.
- ② Turn the switch "II" to "CAPACITY" (Condenser capacity measurement).
- ③ Push the "CAPACITY" button and read the scale on the tester.
Specification 0.21 μ F~0.26 μ F

3. Headlight switch (Inspection with a radio tester)

Start the engine and operate the headlight switch to check to see if the headlight comes on in "ON" position. If the headlight does not come on, check the bulb for condition. If the bulb is burnt out, locate the cause. If the bulb is not burnt out, check the switch for condition. Remove the red and brown connectors and attach the probes of a tester to the connectors and operate the switch to check for continuity. If there is a continuity in "OFF" position and there is no continuity in "ON" position, the switch is defective (Fig. 59, 60).

	C3	HL
ON	○ — ○	
OFF		

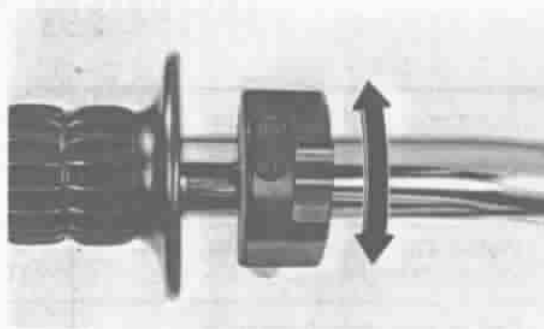
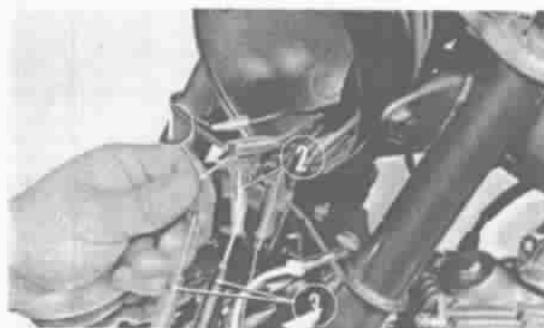

Fig. 59



① Red ② Brown ③ Probes
Fig. 60

4. Ignition switch (kill switch) (Inspection with a radio tester)

Start the engine and operate the switch to check to see if the engine stops in "ON" position.

If the engine does not stop in that position, check in the following manner: Disconnect the primary wire (black) and ground wire (green) of the ignition switch from the connectors. Then attach the probes of a tester to the wires and operate the switch to check for continuity. If there is a continuity in "ON" position and there is no continuity in "OFF" position, the switch is defective (Fig. 61, 62).

	IG	E
ON		
OFF	○ — ○	



Fig. 61

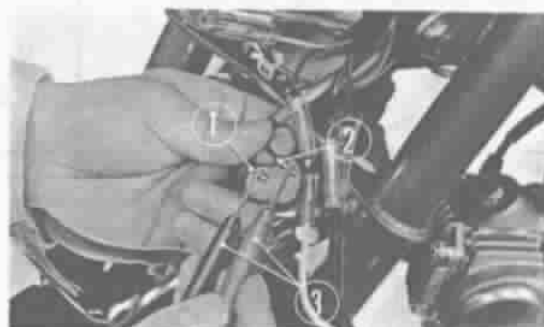

① Black ② Green ③ Probes
Fig. 62

TECHNICAL SERVICE DATA

Unit: mm (in.)

Item	Assembly standard	Service limit
Cylinder bore	39.00~39.01 (1.5354~1.5358)	39.05 (1.5374)
Piston OD	38.98~39.00 (1.5336~1.5354)	38.90 (1.5315)
Piston ring side clearance		
Top and 2nd rings	0.015~0.045 (0.0006~0.0018)	0.10 (0.0039)
Oil ring	0.01~0.045 (0.0004~0.0018)	0.10 (0.0039)
Piston ring gap		
Top and 2nd rings	0.15~0.35 (0.0059~0.0138)	0.5 (0.0197)
Oil ring	0.15~0.40 (0.0059~0.0157)	0.5 (0.0197)
Valve-to-guide clearance		
Intake side	0.01~0.03 (0.0004~0.0012)	0.08 (0.0031)
Exhaust side	0.03~0.95 (0.0012~0.0020)	0.1 (0.0039)
Oil pump body-to-outer rotor clearance	0.1~0.15 (0.0039~0.0059)	0.2 (0.0079)
Inner rotor-to-outer rotor clearance	0.02~0.07 (0.0008~0.0028)	0.12 (0.0047)
Crankshaft journal runout		
Right side	0.015 (0.0006)	0.05 (0.0020)
Left side	0.015 (0.0006)	0.05 (0.0020)
Connecting rod big end play		
Axial direction	0.1~0.35 (0.0039~0.0138)	0.8 (0.0315)
Radial direction	0.010~0.012 (0.0004~0.0005)	0.05 (0.0020)

Unit: mm (in.)

	Item	Assembly standard	Service limit
Front wheel	Front axle bend	0.2 (0.0079)	0.5 (0.0197)
	Ball bearing play		
	Axial direction	0.05 (0.0020)	0.1 (0.0039)
	Radial direction	0.002~0.007 (0.0001~0.0003)	0.05 (0.0020)
	Wheel rim face runout	0.2 (0.0079)	0.5 (0.0197)
	Wheel hub ID	109.9~110.1 (4.327~4.335)	112 (4.409)
	Brake lining thickness	3.9~4.0 (0.1535~0.1575)	2.0 (0.0787)
Rear wheel	Rear axle bend	0.2 (0.0079)	0.5 (0.0197)
	Ball bearing play		
	Axial direction	0.05 (0.0020)	0.1 (0.0039)
	Radial direction	0.002~0.007 (0.0001~0.0003)	0.05 (0.0020)
	Wheel rim face runout	0.2 (0.0079)	0.5 (0.0197)
	Wheel hub ID	109.9~110.1 (4.327~4.335)	112 (4.409)
	Brake lining thickness	3.9~4.0 (0.1535~0.1575)	2.0 (0.0787)
	Front shock absorber spring free length	166.8 (6.567)	

(The above service data are subject to change without notice or obligation.)

TORQUE SPECIFICATIONS

(ENGINE)

	Item	Q'ty	Torque values	
			kg-m	ft-lbs
1	Cylinder head cover	4	0.9~1.2	6.5~ 8.6
2	Cam sprocket	3	0.8~1.2	5.7~ 8.6
3	Cylinder tighten	1	0.8~1.2	5.7~ 8.6
4	L. crankcase cover	3	0.7~1.1	5.1~ 7.9
5	Flywheel	1	3.0~3.8	21.7~27.4
6	R. crankcase cover	8	0.7~1.1	5.1~ 7.9
7	Clutch tighten	1	3.5~4.5	25.3~32.5
8	Shift drum stopper	1	0.9~1.4	6.5~10.2
9	Drain cock bolt	1	2.0~2.6	14.5~18.0
10	Drive sprocket	2	0.8~1.2	5.7~ 8.6

(FRAME)

	Item	Q'ty	Torque values	
			kg-m	ft-lbs
1	Front axle	1	3.0~4.0	21.7~28.9
2	Front cushion	2	2.0~2.5	14.5~18.1
3	Rear axle	1	2.5~3.5	18.0~23.6
4	Rear cushion	2	2.5~3.5	18.0~23.6
5	Rear fork pivot	1	2.5~3.5	18.0~23.6
6	Engine hanger bolt	2	2.0~2.5	14.5~18.1
7	Torque link tighten bolt	1	2.0~2.5	14.5~18.1
8	Steering stem	1	6.0~8.0	43.2~57.6
9	Driven sproket	1	1.8~2.3	13.0~16.6
Standard parts				
	Bolt hex. 6 mm		0.8~1.2	5.7~ 8.6
	Bolt hex. 8 mm		2.0~2.4	14.5~17.3
	Screw cross. 6 mm		0.8~1.2	5.7~ 6.6

WIRING DIAGRAM

GENERAL EXPORT TYPE

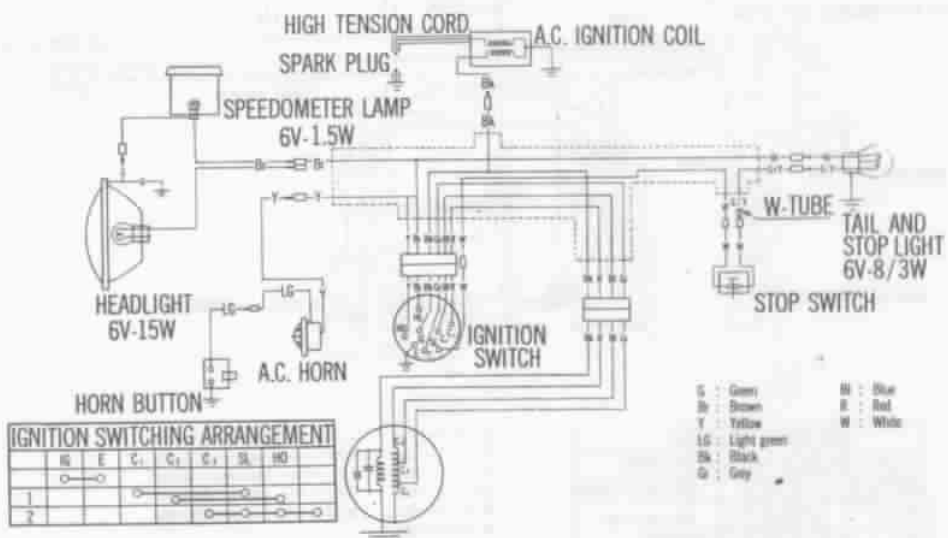

U.S.A. TYPE (From F. No. 120001)

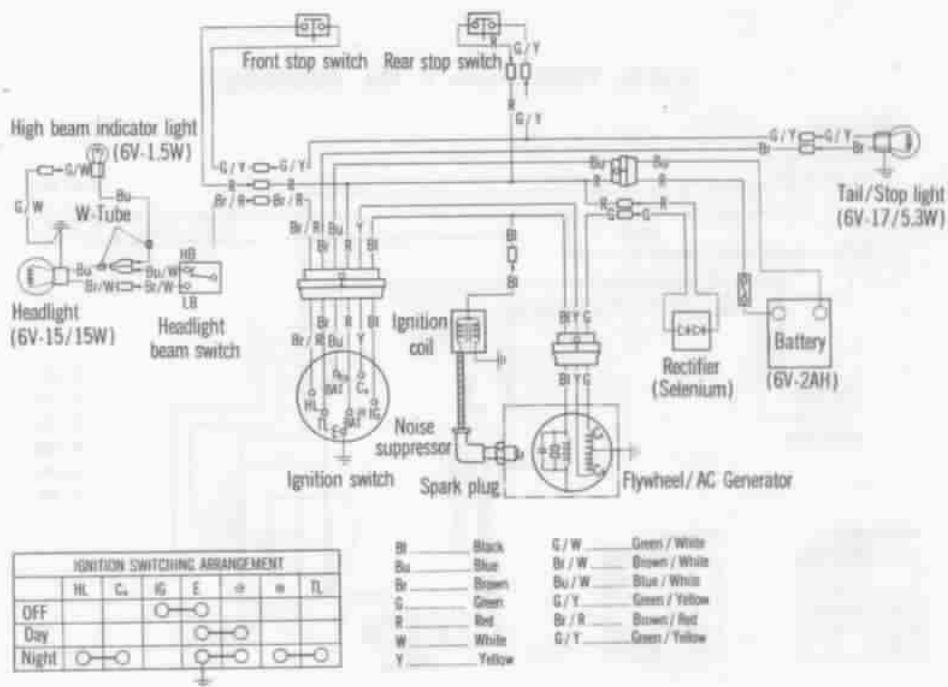

U.S.A. TYPE (From F. No. 270236)

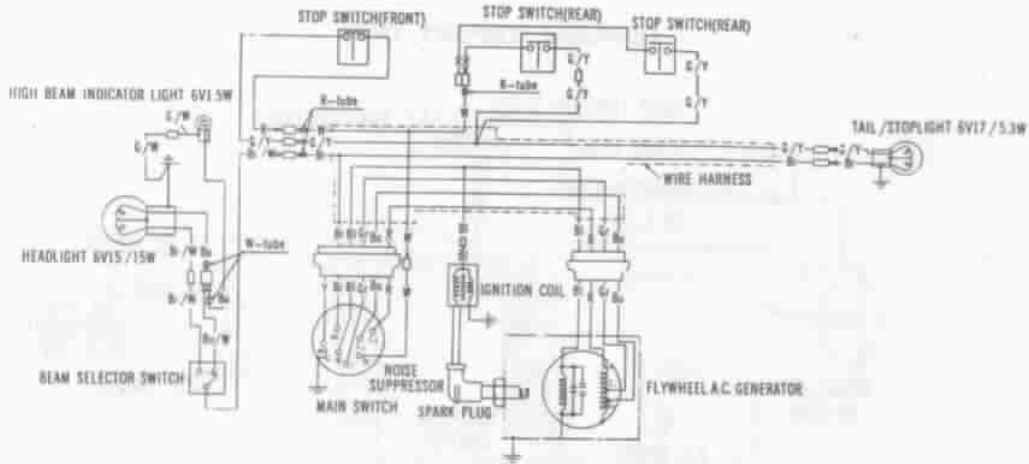

MAIN SWITCH ARRANGEMENT						
IR	E	C ₁	C ₂	SL	HO	HL
OFF	○	○	○	○	○	○
I				○	○	
II				○	○	○

- B... Black
- Bs... Blue
- Bg... Brown
- C... Green
- G... Grey
- R... Red
- W... White
- C/W... Green with White spiral
- Bs/W... Brown with White spiral
- C/Y... Green with Yellow spiral
- Sl/W... Black with White spiral
- Bs/W... Blue with White spiral

U.S.A. TYPE (From F. No. 5000001)

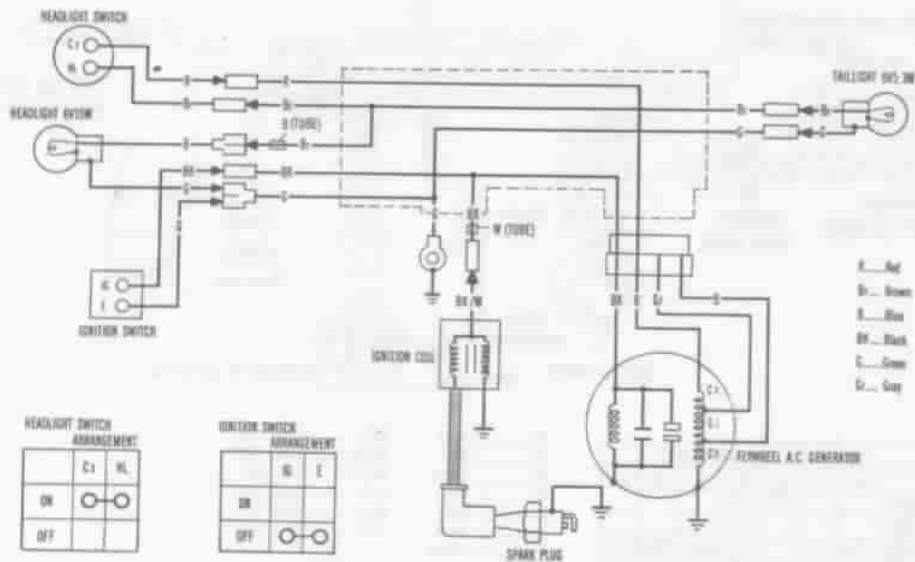

HEADLIGHT SWITCH ARRANGEMENT		
ON	C ₁	HL
ON	○	○
OFF		

IGNITION SWITCH ARRANGEMENT		
ON	SL	E
ON		
OFF	○	○

- R... Red
- Bs... Brown
- B... Blue
- Bk... Black
- C... Green
- G... Grey